

KMS Technologies - KJT Enterprises Inc.

Presentation

Strack, K. – M.

2004

**Resistivity Logging
Past, present & future**

Society of Physics Students,
Technical Meeting, Dhahran, Saudi Arabia

Resistivity Logging

Past, present & future

K. Strack
KMS Technologies - KJT Enterprises Inc.

June 2004

1/2 Oil

1/2 Water

Water

Resistivity logging: Past, Present & Future

- Introduction
- Past
 - ☒ History
 - ☒ Older tools
 - ☒ Pitfalls
- Present
 - ☒ Overall concept
 - ☒ Improved tools
 - ☒ Innovative tools
 - ☒ Interpretation
- Future

Resistivity logging: Past, Present & Future

- Introduction
- Past
 - ☒ History
 - ☒ Older tools
 - ☒ Pitfalls
- Present
 - ☒ Overall concept
 - ☒ Improved tools
 - ☒ Innovative tools
 - ☒ Interpretation
- Future

Objective

- Provide a resistivity logging snapshot
- Stay with wireline only (MWD later)
- Link past & future developments

Oil - Resistivity relationship

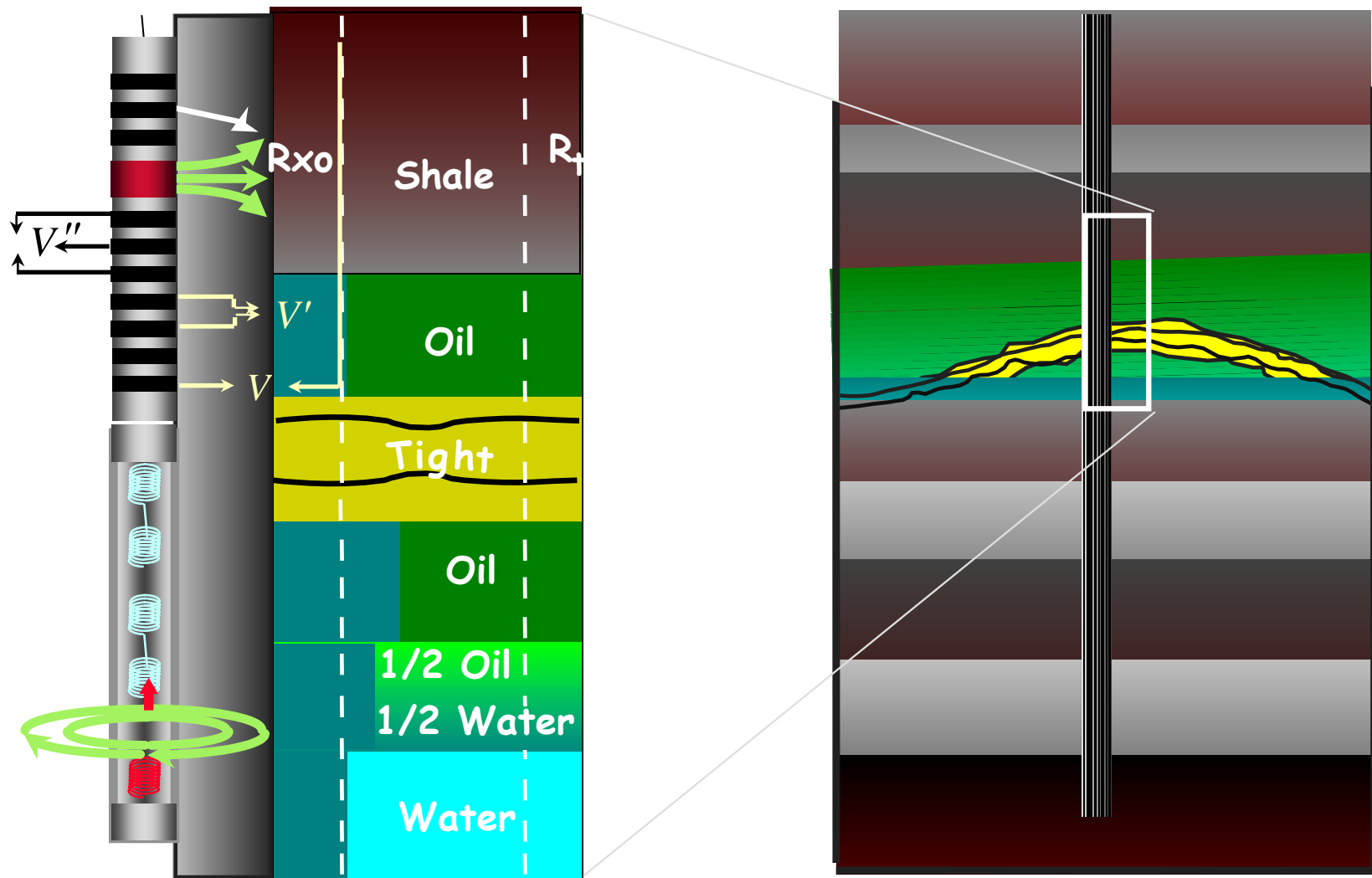

Resistivity logging: Past, Present & Future

- Introduction
- **Past**
 - ☒ History
 - ☒ Older tools
 - ☒ Pitfalls
- **Present**
 - ☒ Overall concept
 - ☒ Improved tools
 - ☒ Innovative tools
 - ☒ Interpretation
- **Future**

The fun of ancient logging

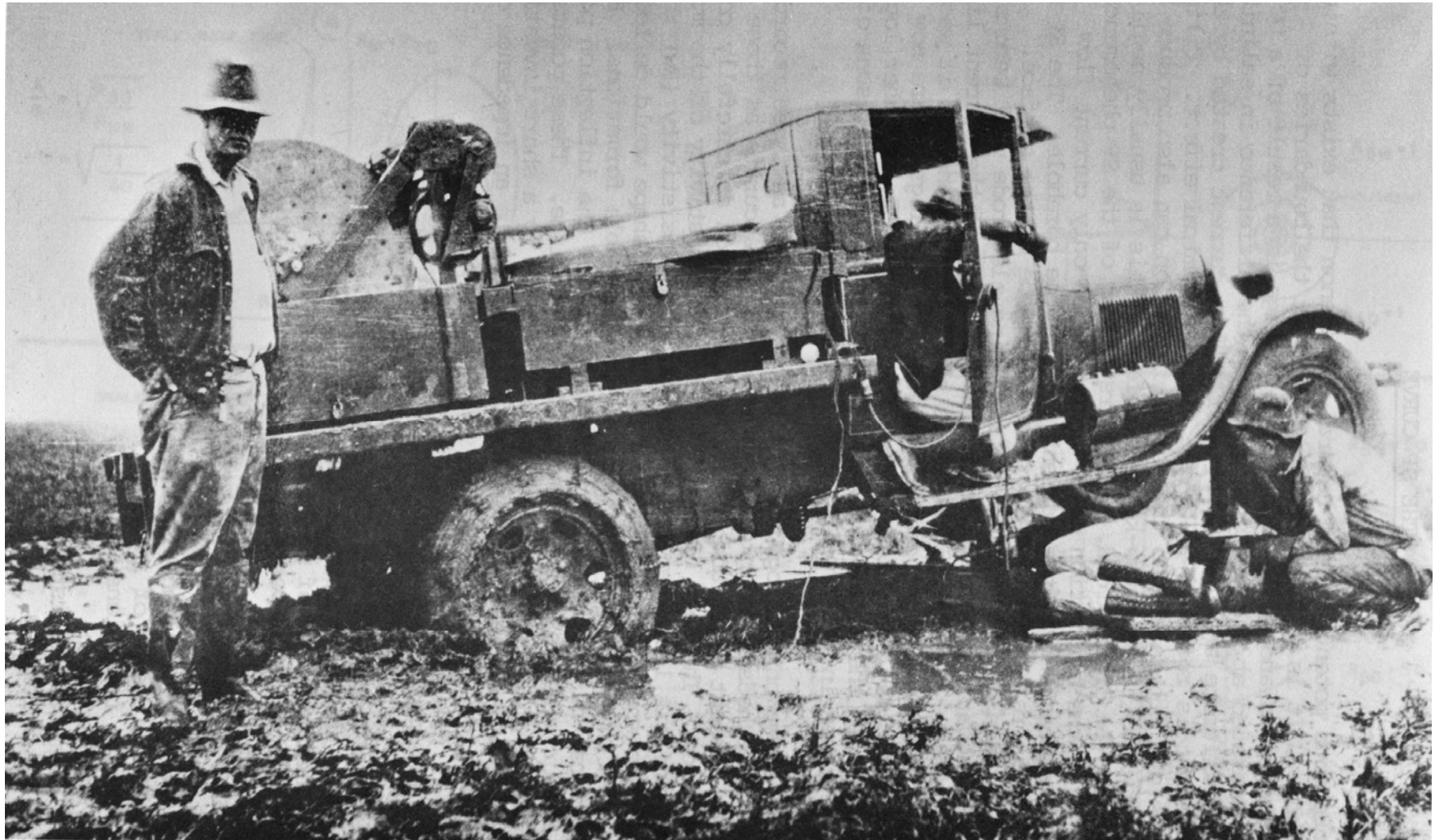

After SPWLA, 1979

The Phases

- 1921 - 1927 Conceptual Phase
- 1927 - 1949 Acceptance Phase
- 1949 - 1985 Maturity Phase
- Since 1985 - Reinvention Phase

- Historically:
 - ⊗ Schlumberger dominated (exceptions: MPI, EMI)
 - ⊗ During 1990 Baker caught up and developed new tools (3DEX and TCR)

After Luthi 2001

Resistivity logging: Past, Present & Future

- Introduction
- **Past**
 - ☒ History
 - ☒ Older tools
 - ☒ Pitfalls
- **Present**
 - ☒ Overall concept
 - ☒ Improved tools
 - ☒ Innovative tools
 - ☒ Interpretation
- **Future**

Resistivity tools underlying principle

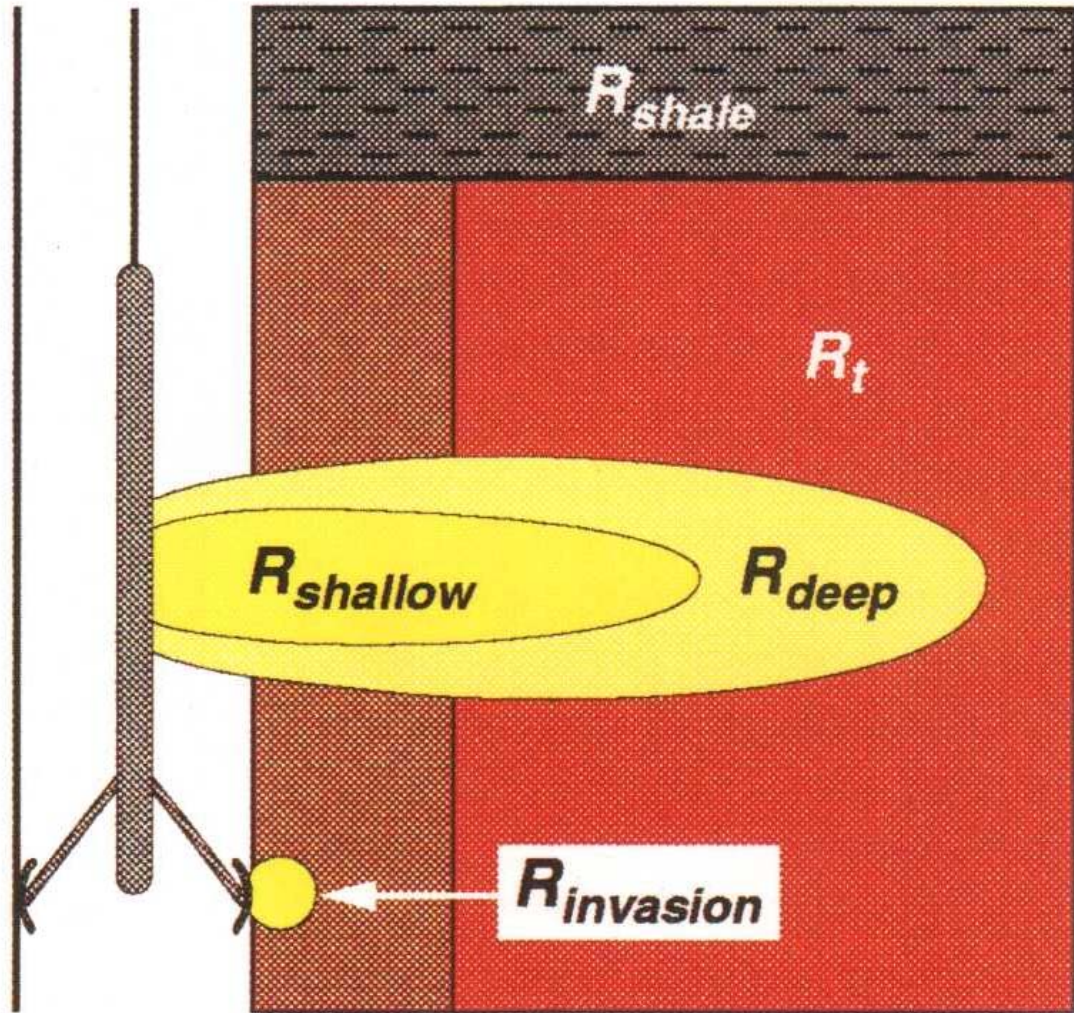

(after van Ditzhuijzen, 1994)

 = Uninvaded reservoir  = Invaded reservoir

Electric resistivity devices

- Normal log
- Lateral log
- LL3
- LL7, DLL
- LL8 - as LL7 but shorter spacing & return
- Rxo logs
- Diplogs

Normal and lateral principle

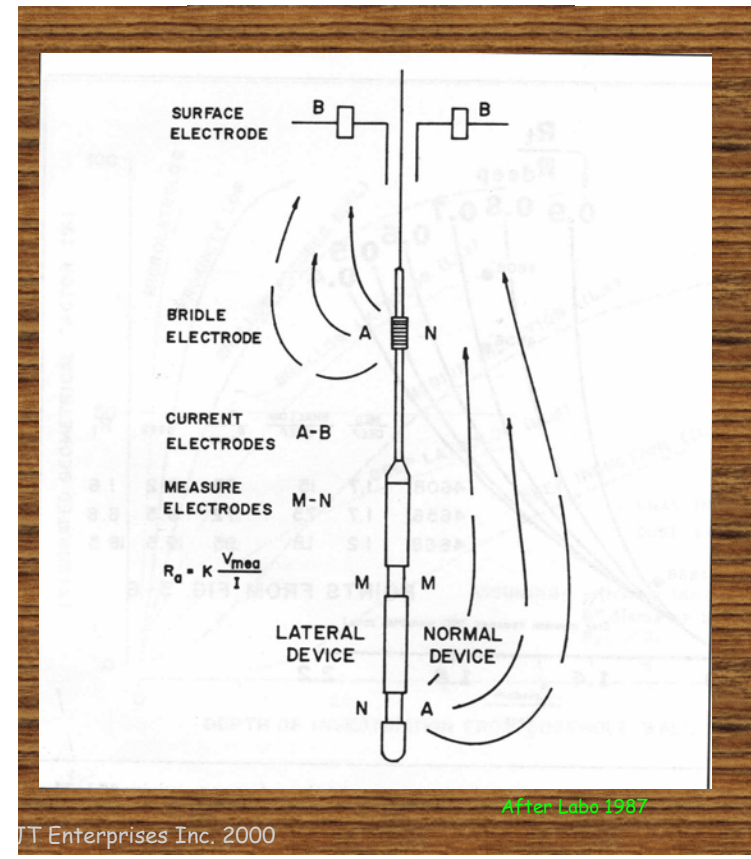
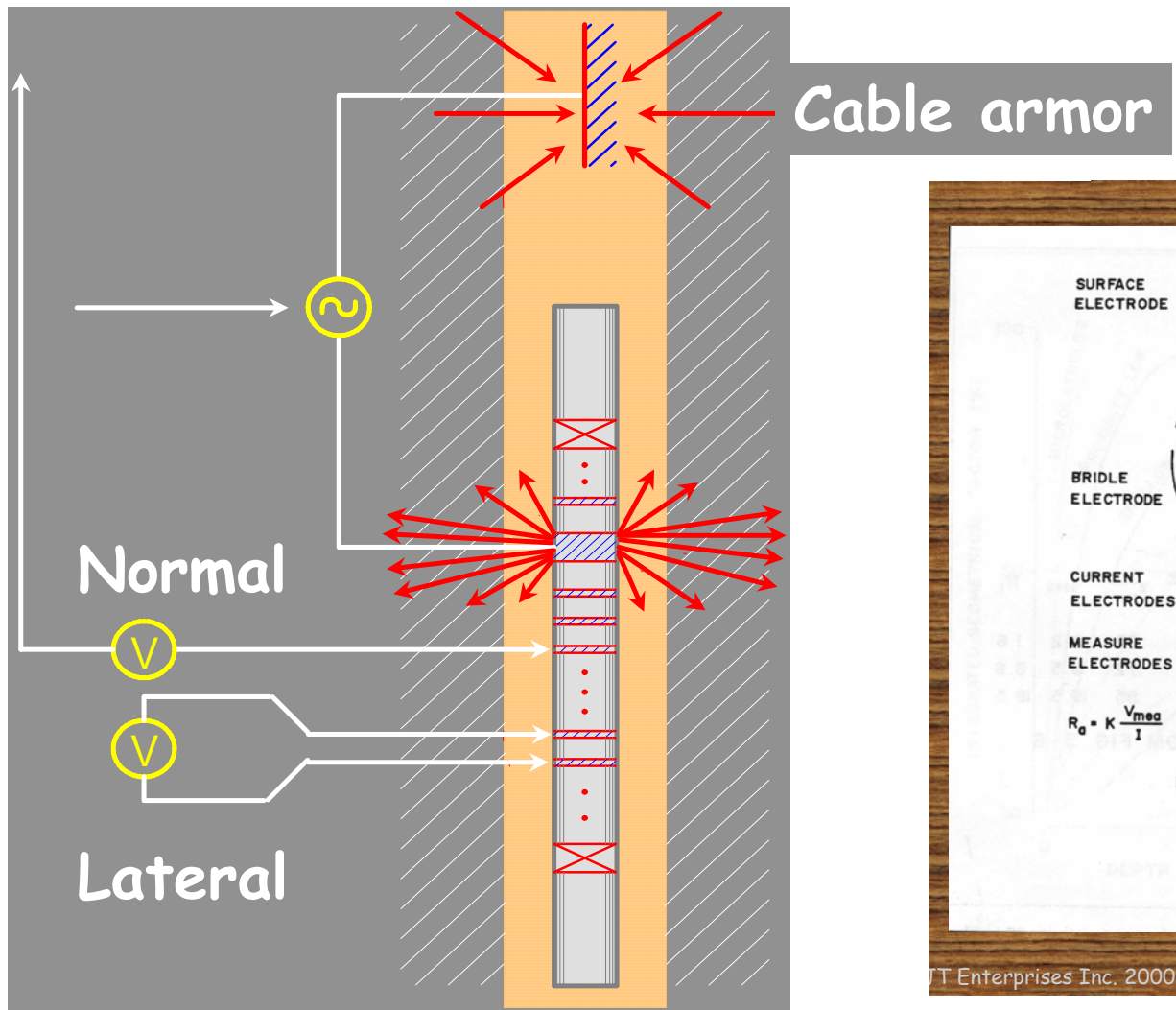

Normal & lateral log curves

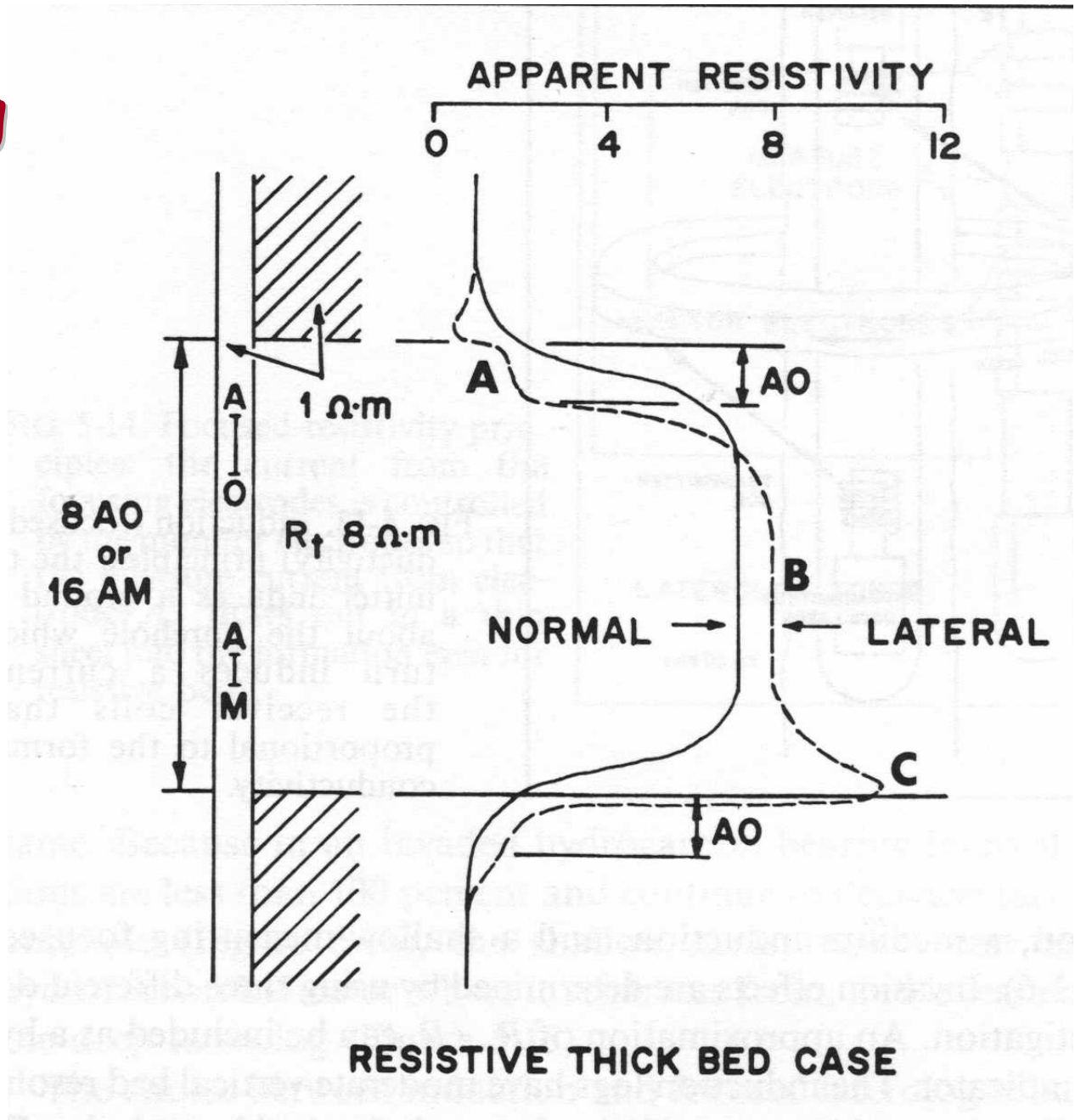

After Labo 1987

LL3 and LL7

LL3

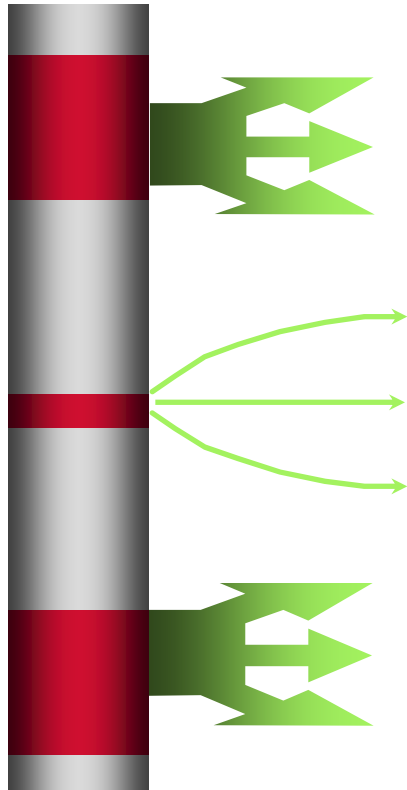

LL7, DLL

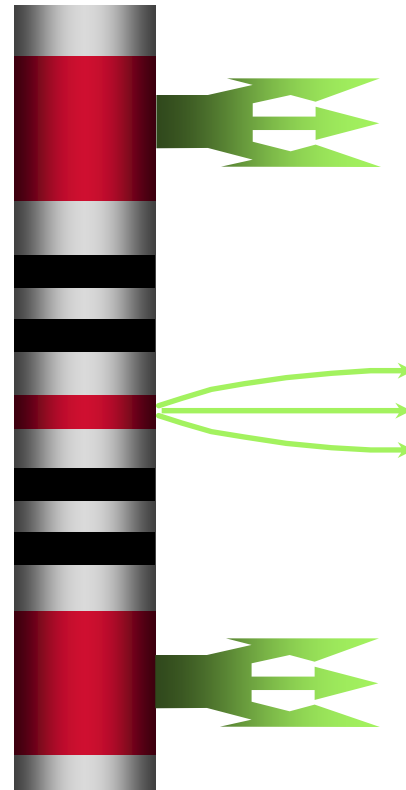

Micro-SFL principle

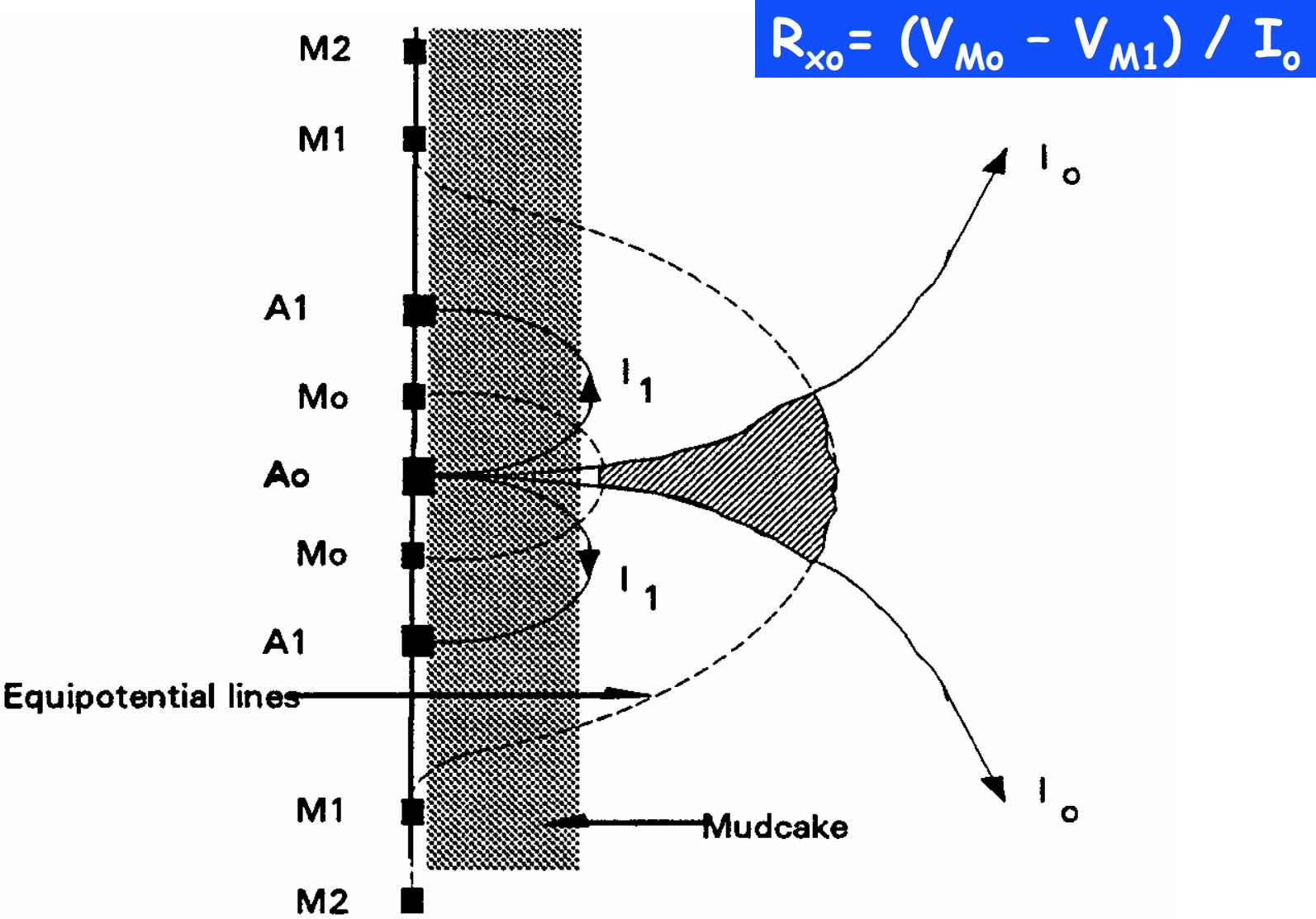

After Peeters, 1995, Schlumberger

Microlog picture

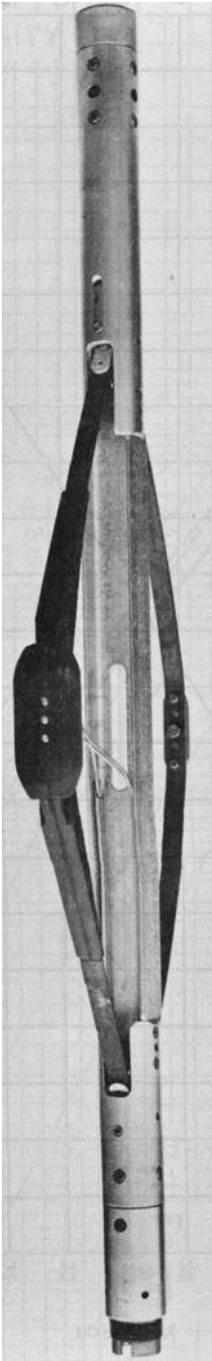
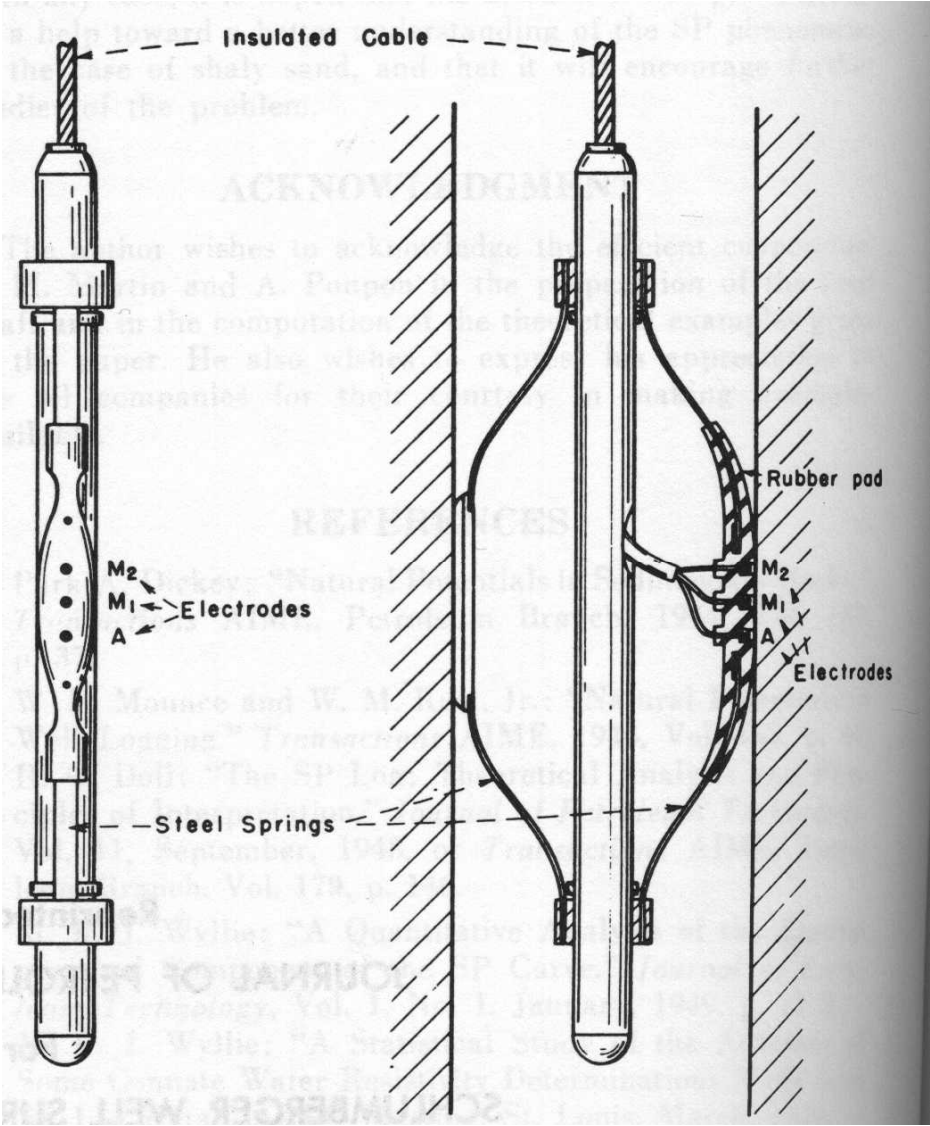

After SPWLA, 1979

Dipmeter tool principle

Different environments

- Water based mud
- Oil based mud

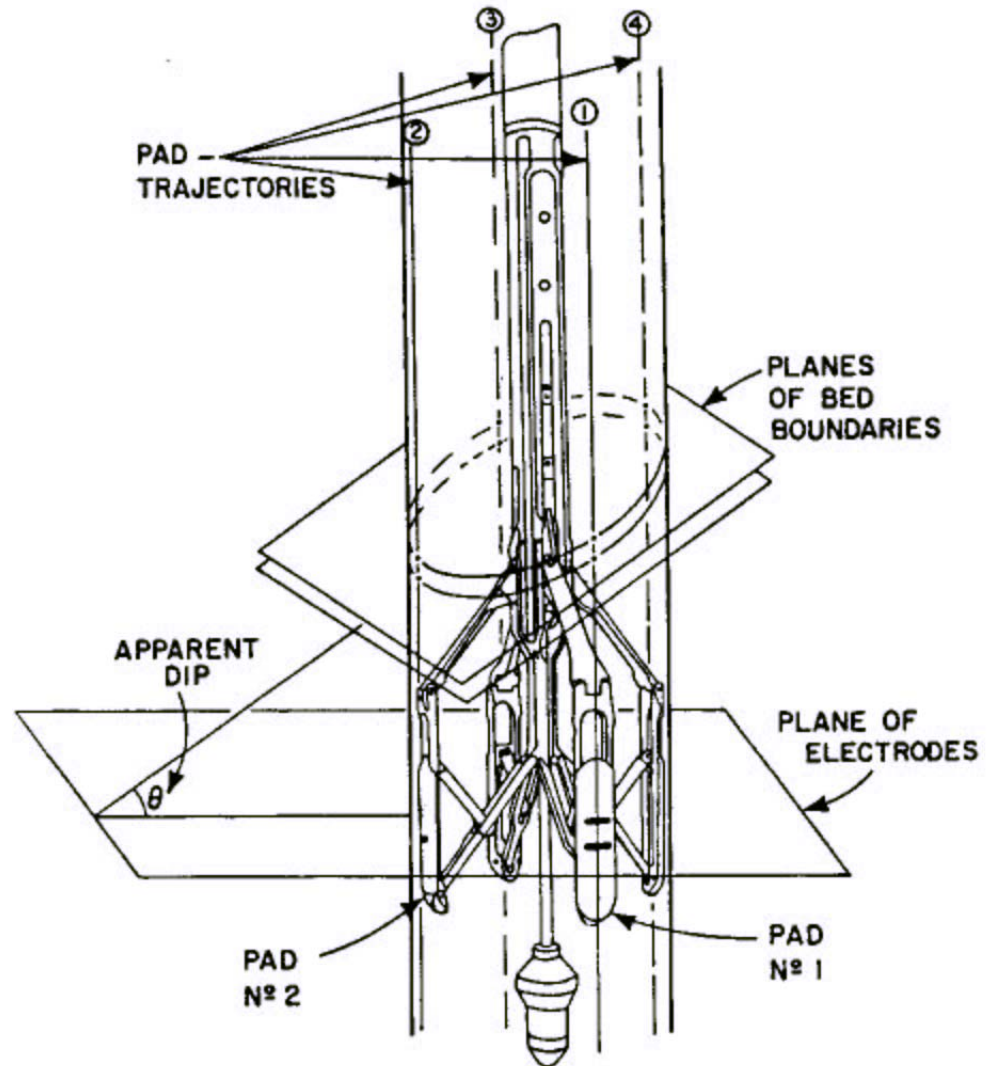

After Luthi, 2001

Diplog principle

- used in water based mud

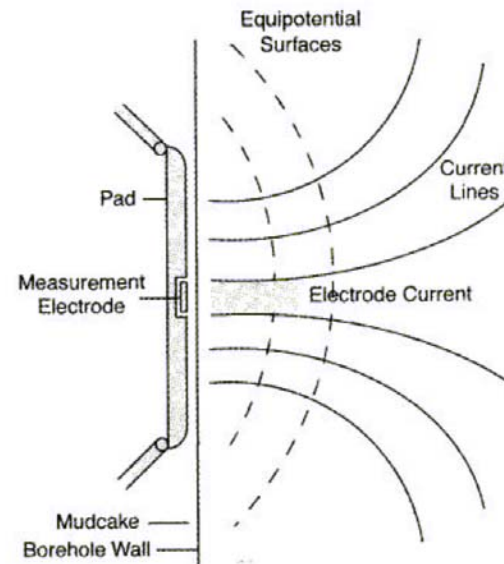
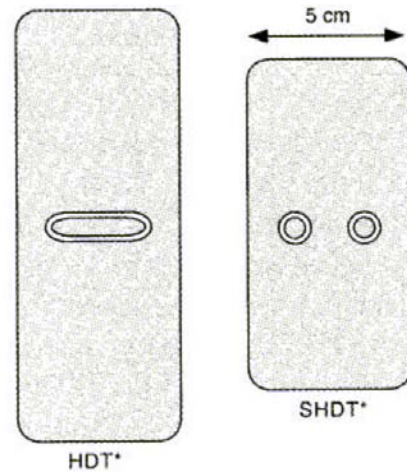

After Luthi, 2001

OBM dip tool principle

- used in oil based mud

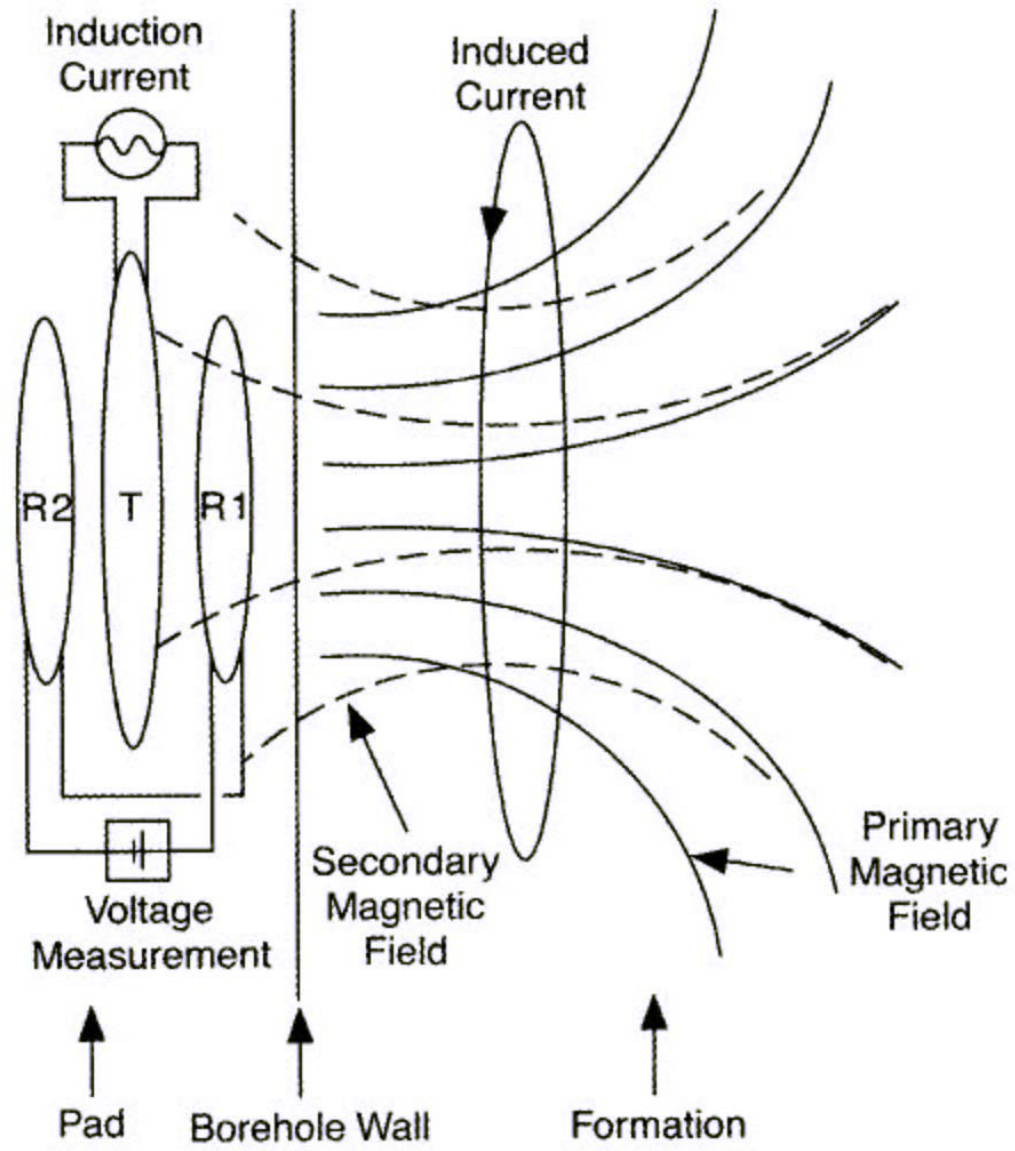

After Luthi, 2001

SLB's dip log tool: SHDT

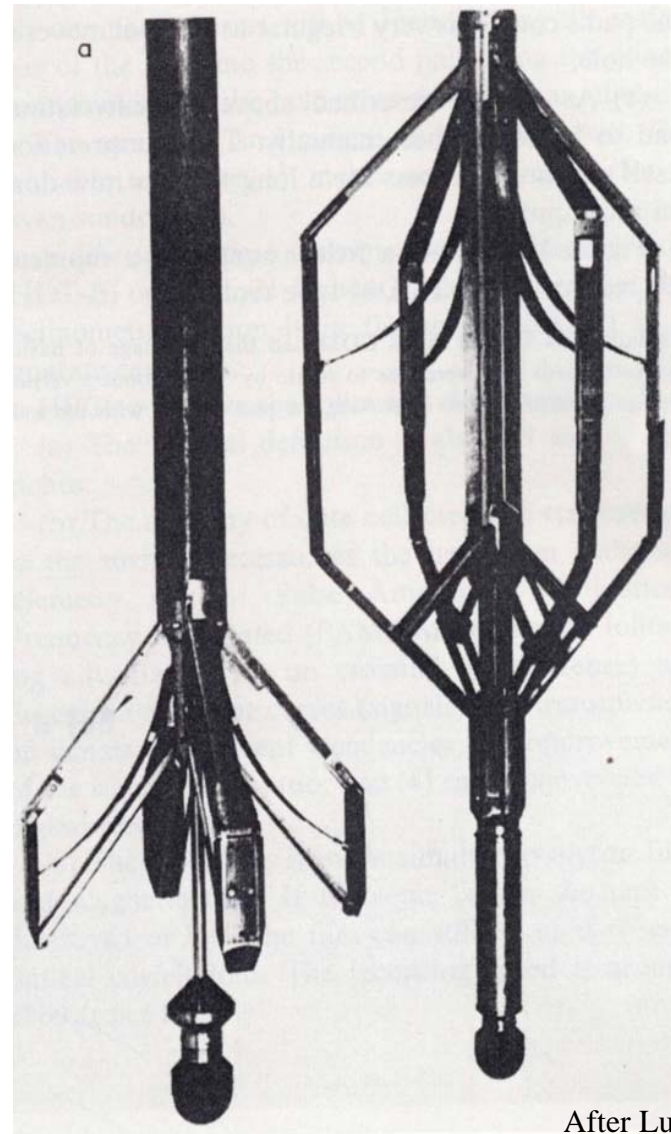
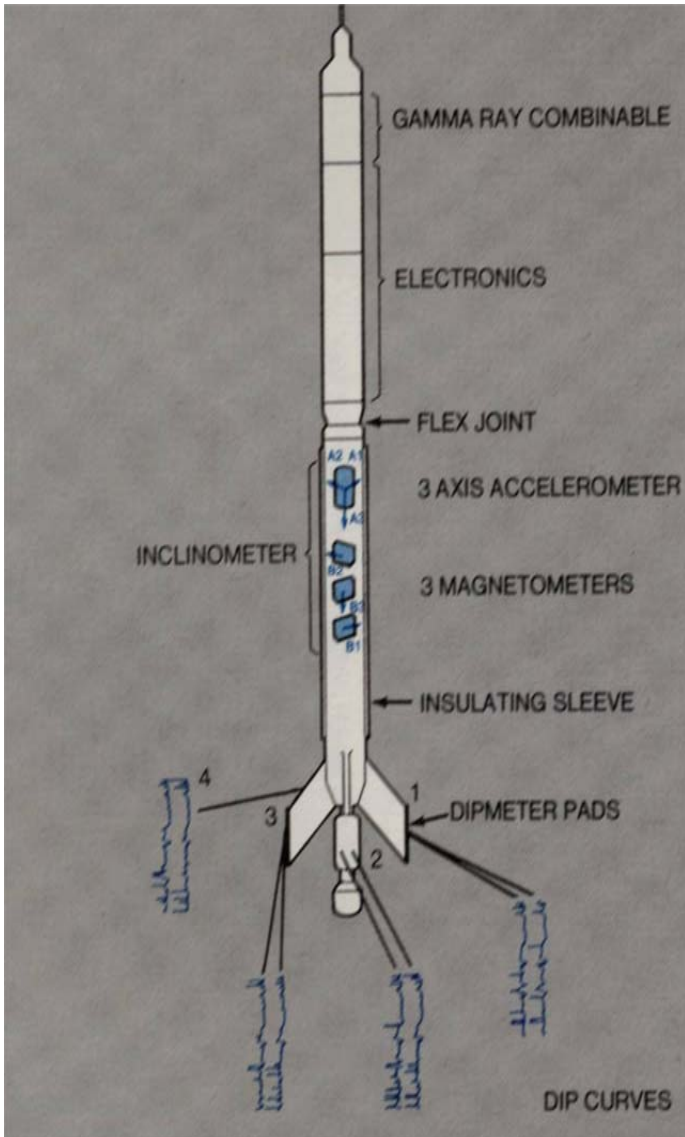

After Luthi, 2001

SHDT™ diplog example

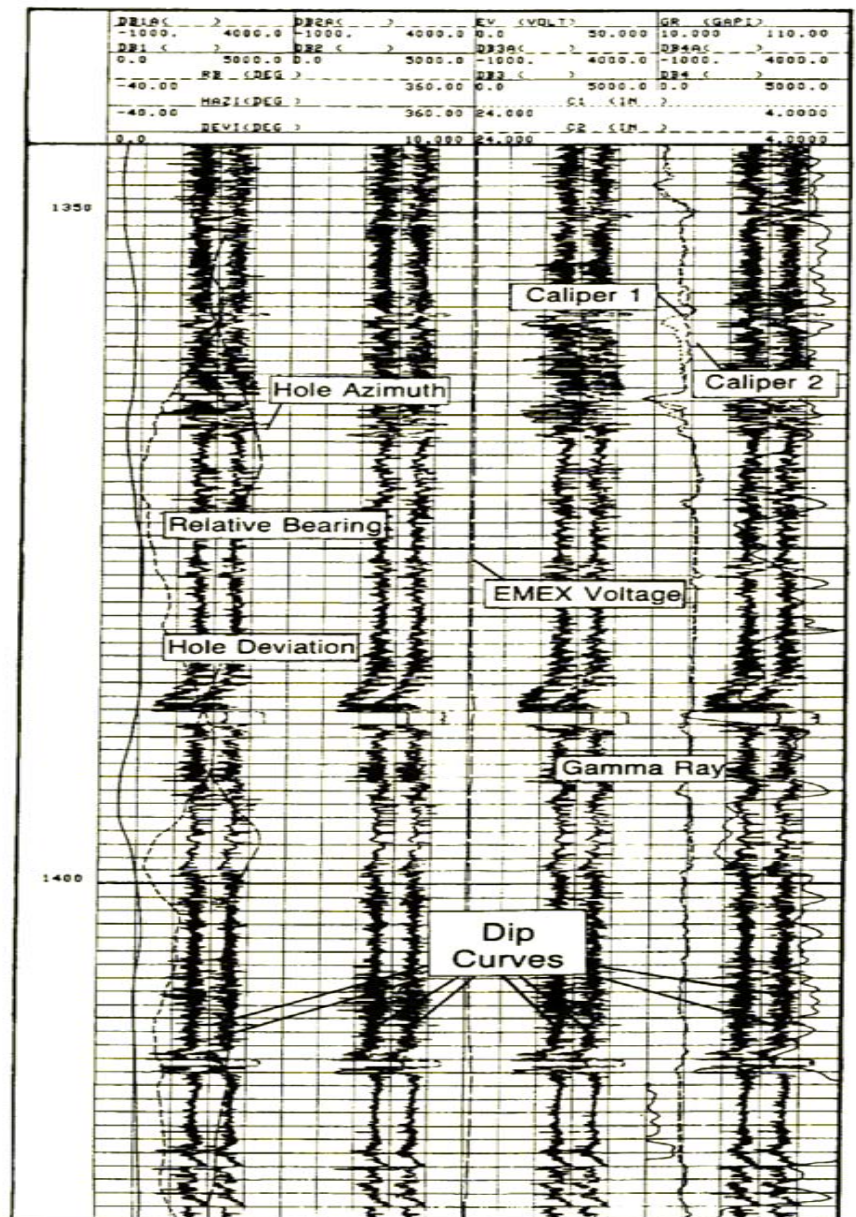

After Luthi, 2001

Resistivity logging: Past, Present & Future

- Introduction
- **Past**
 - ☒ History
 - ☒ Older tools
 - ☒ **Pitfalls**
- **Present**
 - ☒ Overall concept
 - ☒ Improved tools
 - ☒ Innovative tools
 - ☒ Interpretation
- **Future**

Pitfalls: Laterolog - invaded layers

bhd = 8 in.
Rm = 0.15 W m

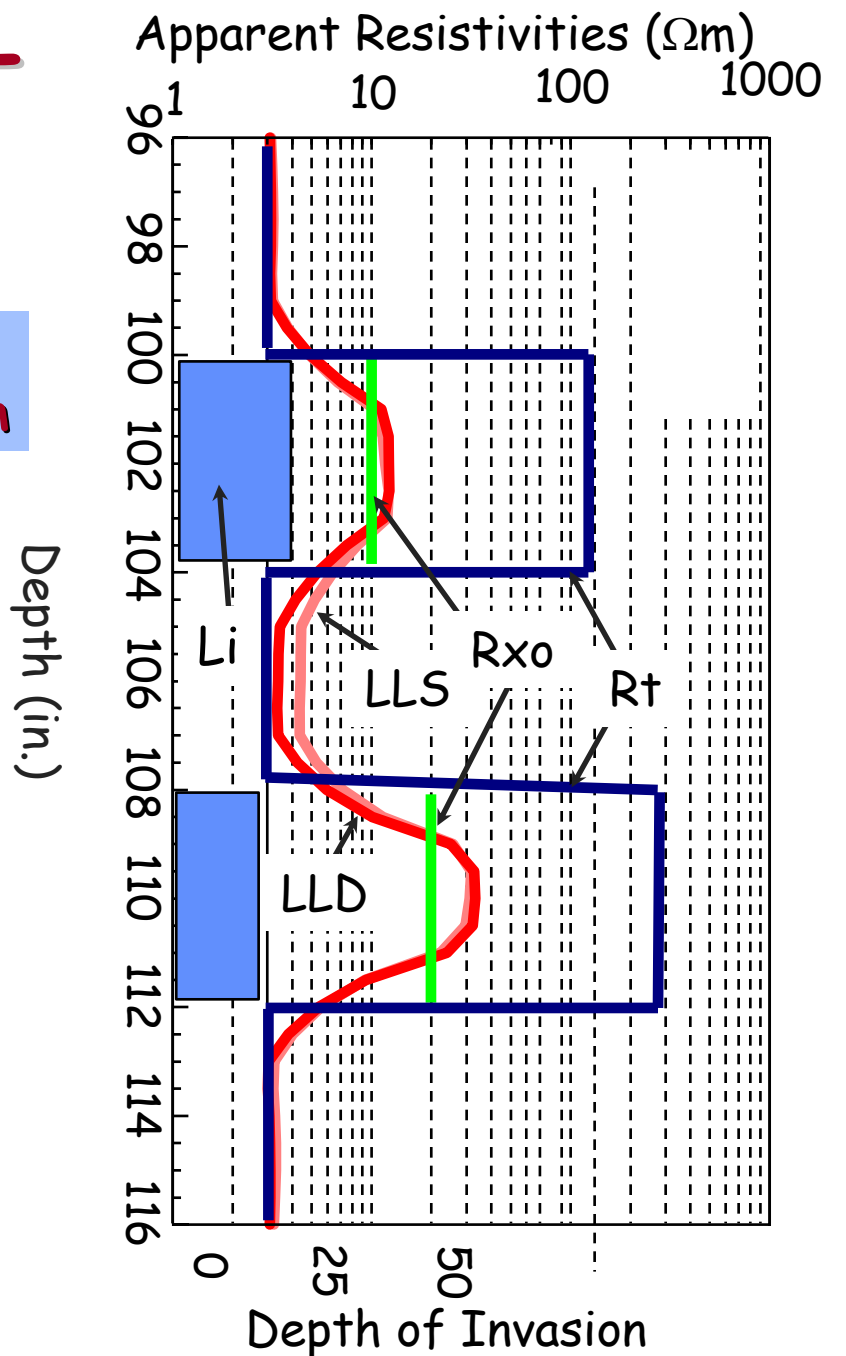

After Mezzatesta, 1996

2-D Inversion Results

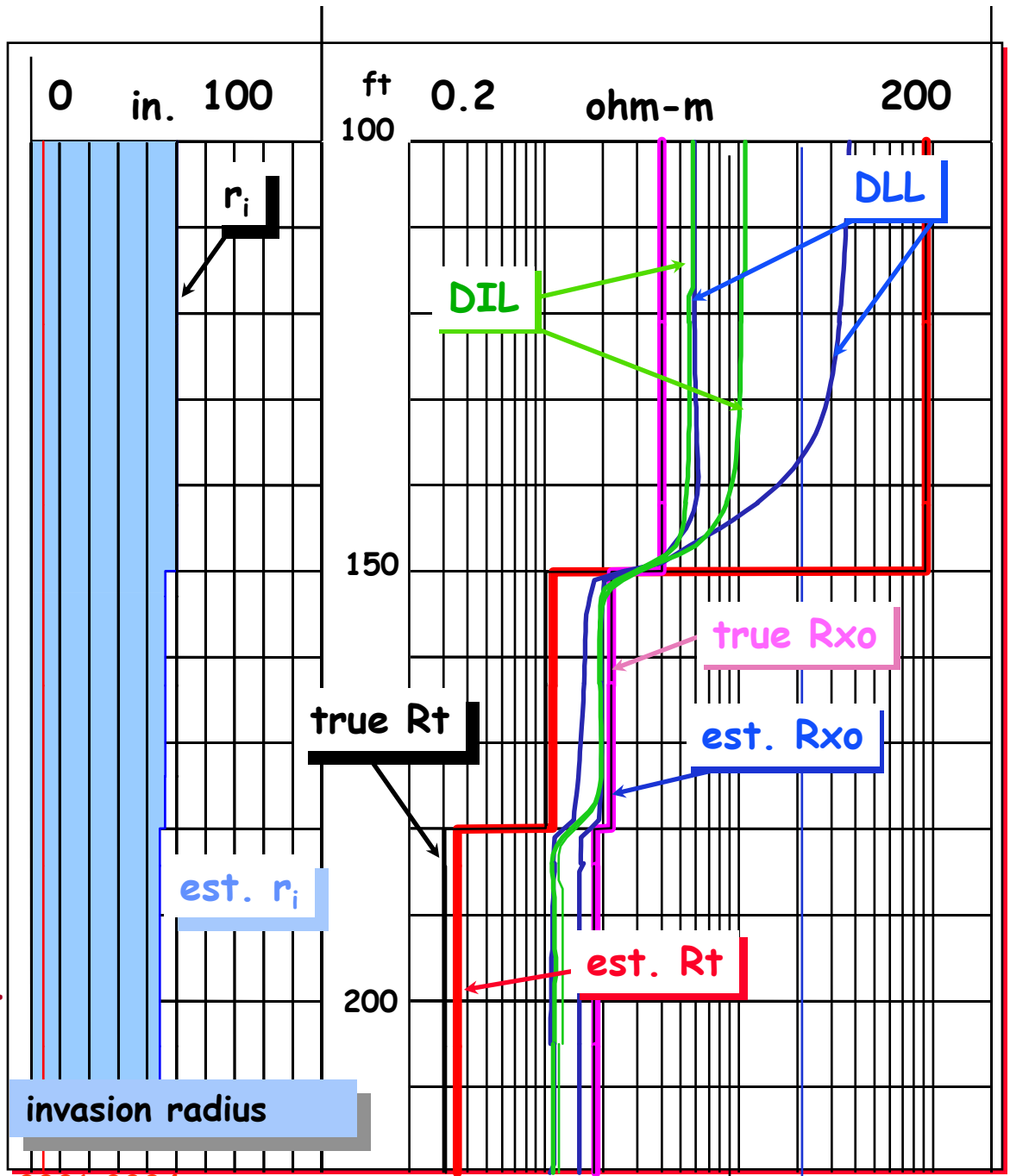

from The Log Analyst, 1994

After Strack et al., 1998

Pitfalls: Induction logs

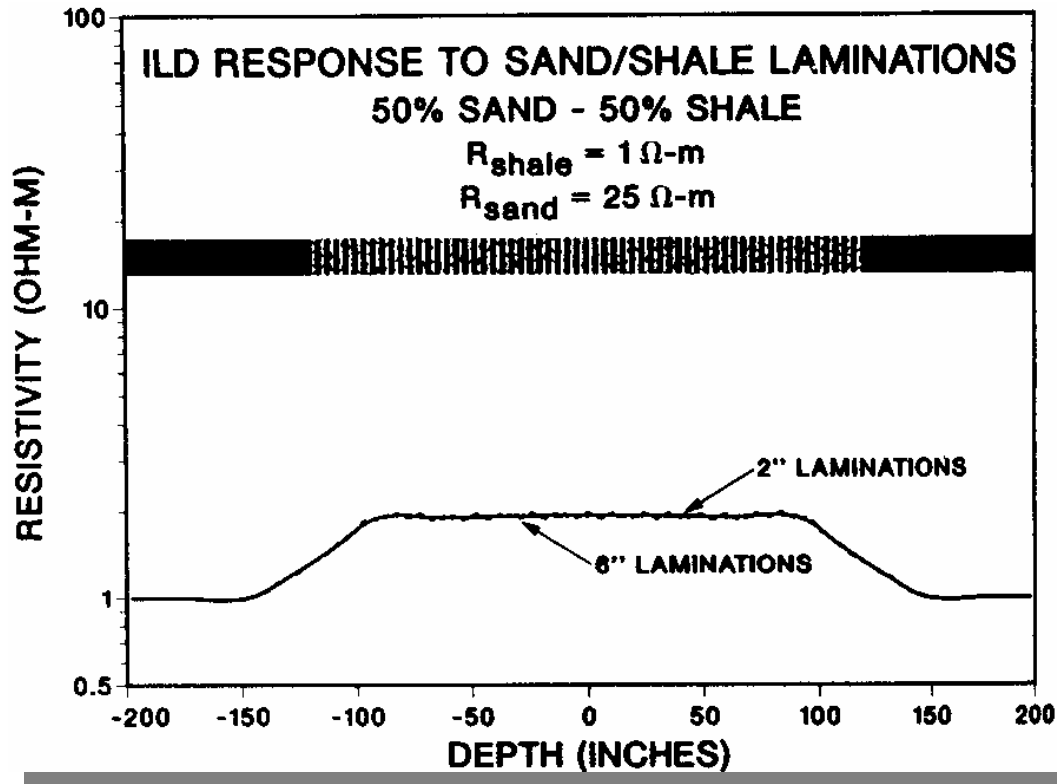

After Anderson, 1986

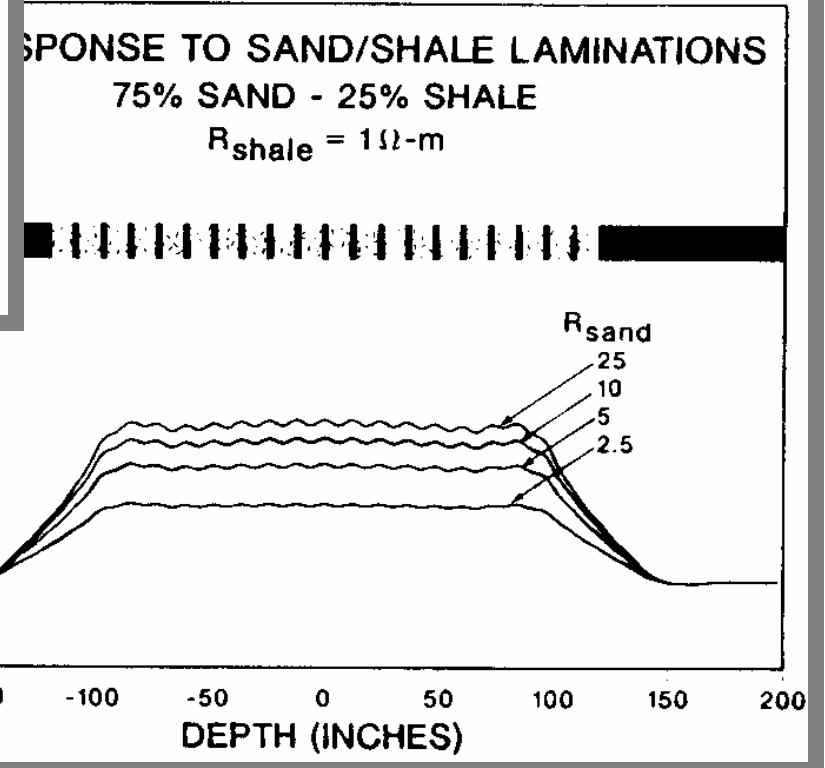

Resistivity logging: Past, Present & Future

- Introduction
- Past
 - ⊗ History
 - ⊗ Older tools
 - ⊗ Pitfalls
- Present
 - ⊗ Overall concept
 - Direct image of geology
 - More data
 - New measurements
 - Better understanding of measurements & geology
 - ⊗ Improved tools
 - ⊗ Innovative tools
 - ⊗ Interpretation
- Future

9.0 8.5 8.0 7.5 7.0 6.5 6.0 5.5 5.0 4.5 4.0 3.5 3.0 2.5 2.0 1.5 1.0

Combined photo & image

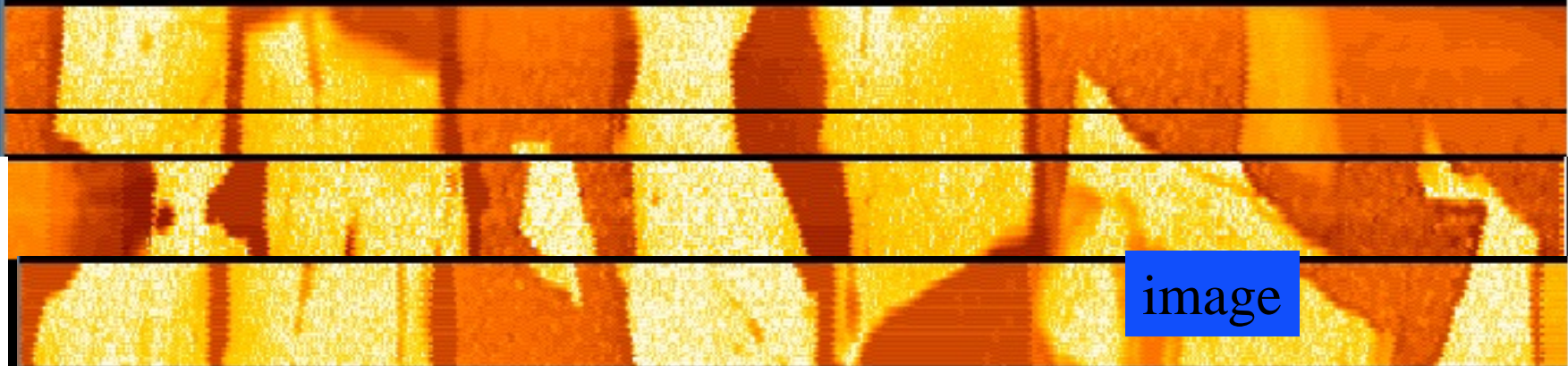

image

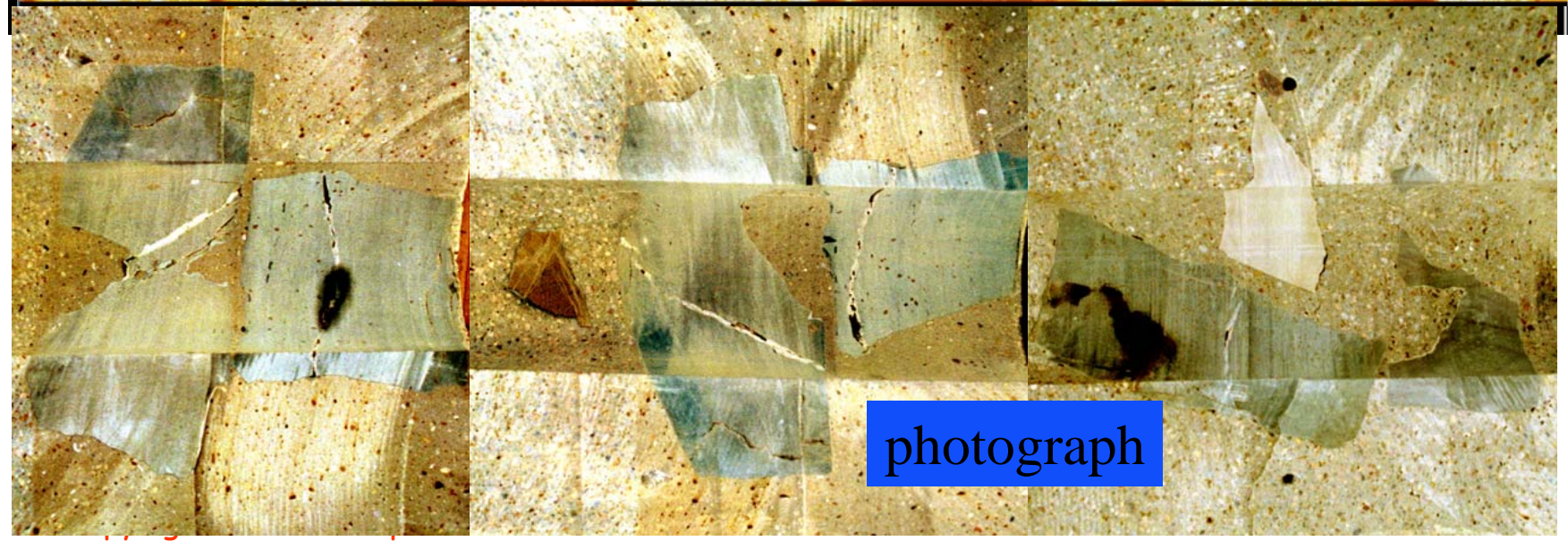

photograph

From meters to acquisition systems

Limits

Possibilities

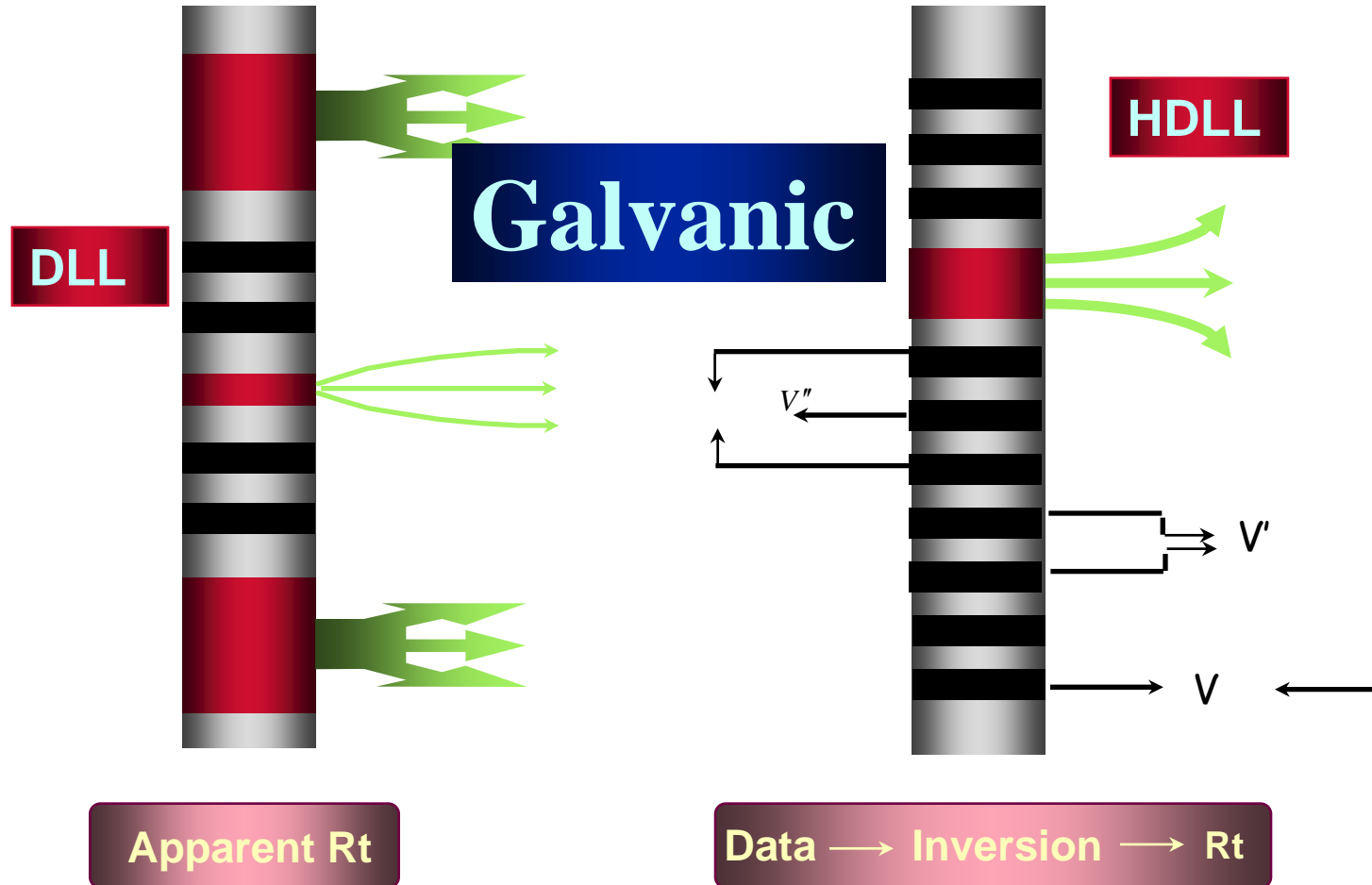

After Strack, 1999

From meters to acquisition systems

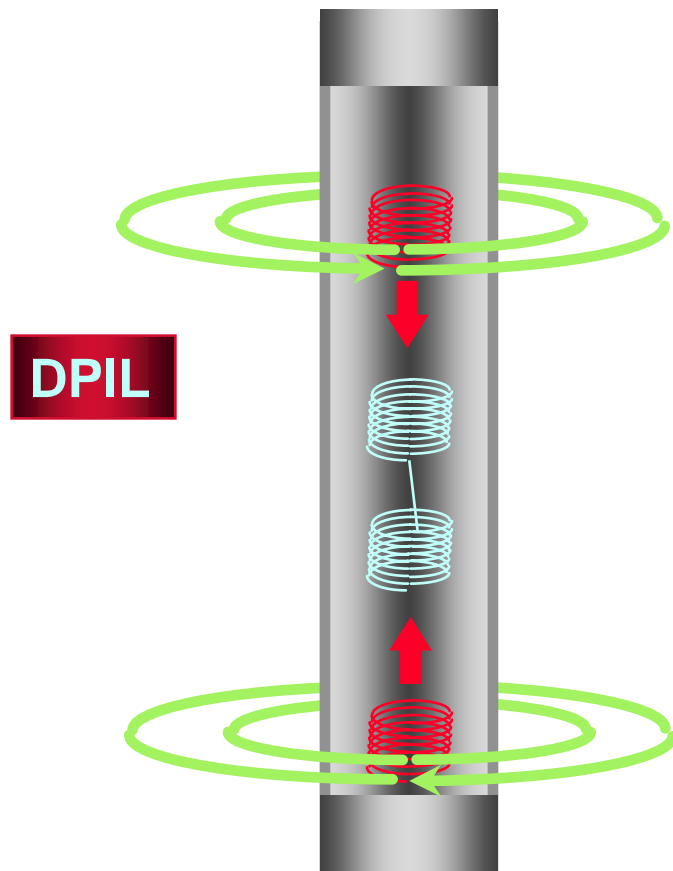

Apparent R_t

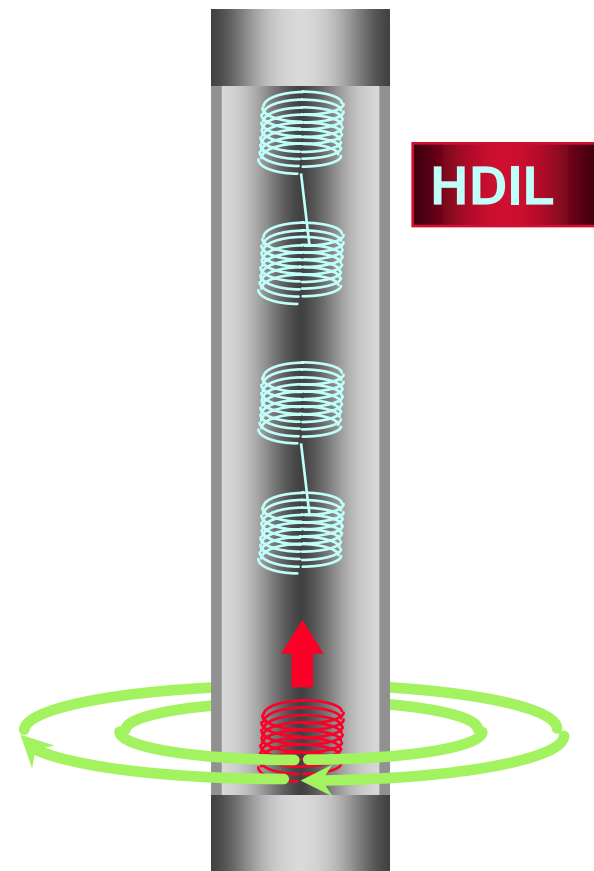

Raw Array \rightarrow Data Inversion \rightarrow R_t

After Strack et al., 1998

© Copyright KJT Enterprises Inc. 2001-2004

Resistivity logging: Past, Present & Future

- Introduction
- Past
 - ⊗ History
 - ⊗ Older tools
 - ⊗ Pitfalls
- Present
 - ⊗ Overall concept
 - ⊗ Improved tools
 - Image tools (WBM & OBM)
 - Array tools (Induction & Laterologs)
 - ⊗ Innovative tools
 - ⊗ Interpretation
- Future

From diplog to imaging

- Imaging started with dip logs
- Today multi button imagers replace most dip logs
- Image tool are used for geologic interpretation
- Could be used also for reserve estimates

How the display is derived

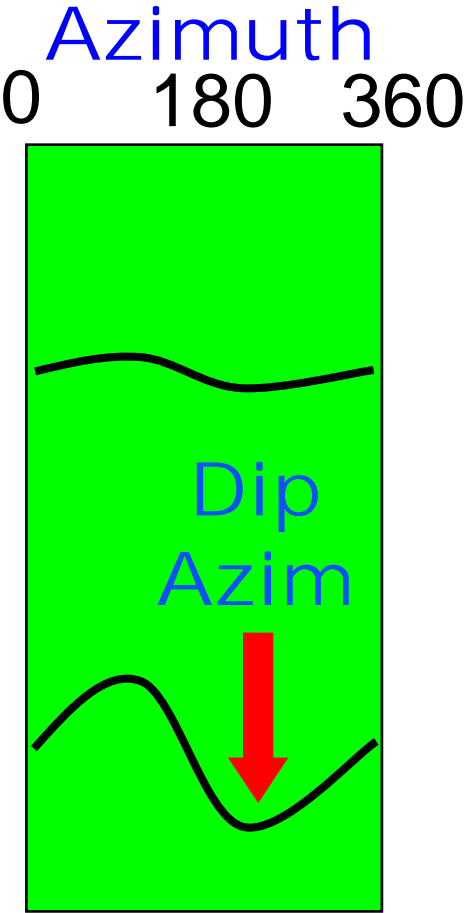
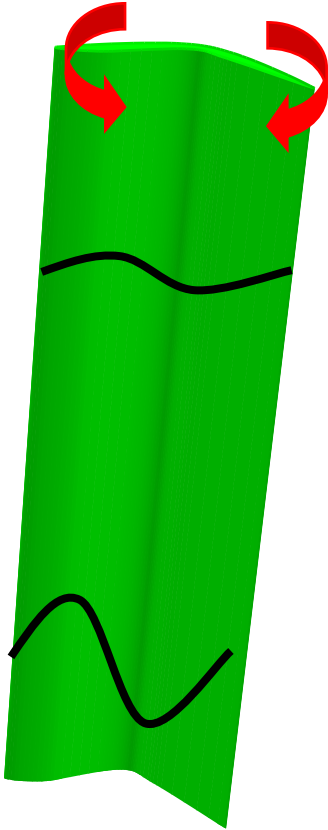
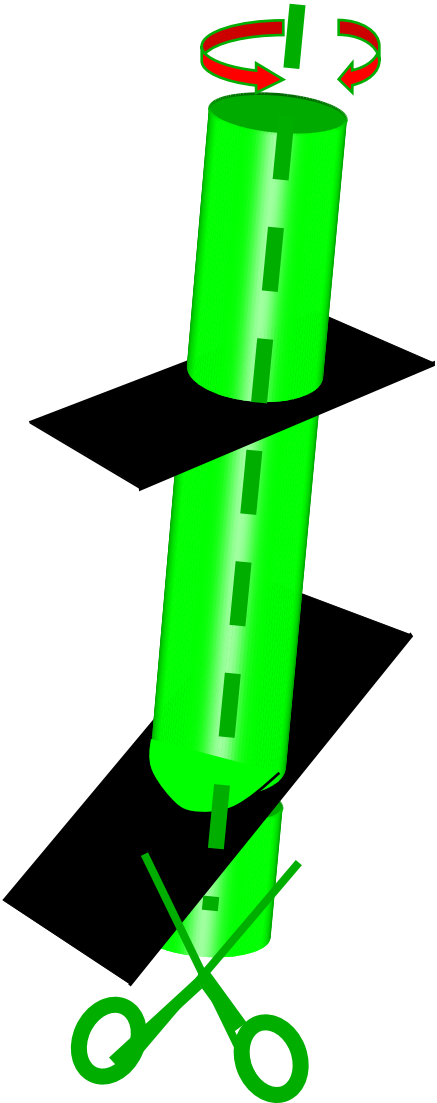

Example

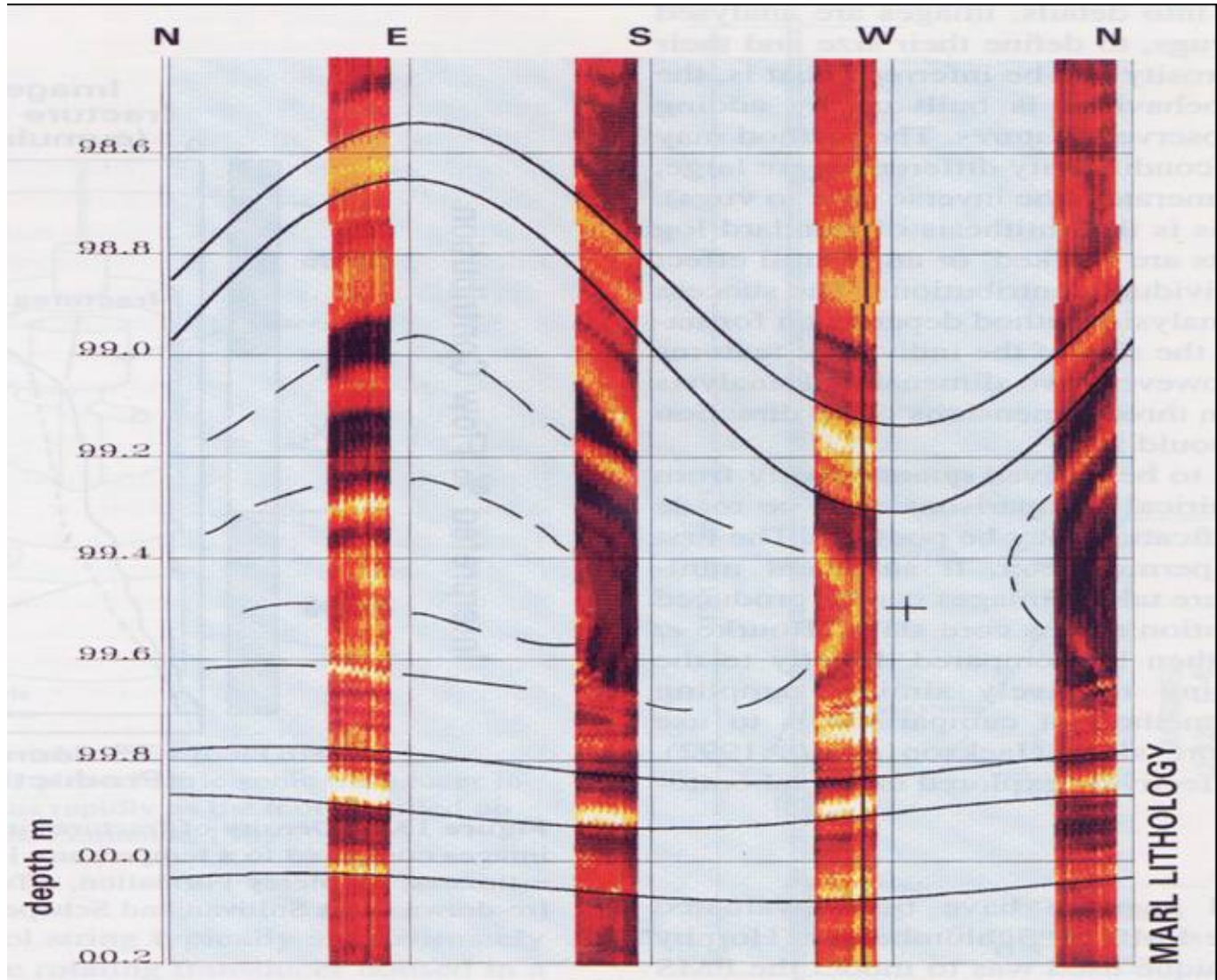

After Rider, 1996

© Copyright KJT Enterprises Inc. 2001-2004

Current electrical imagers

6 alternately offset electrical imaging pads

Powered standoff centralizes tool

CBIL is attached to lower end of tool string



FMI

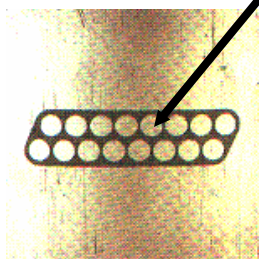

STAR

EMI

Pad with 25 buttons

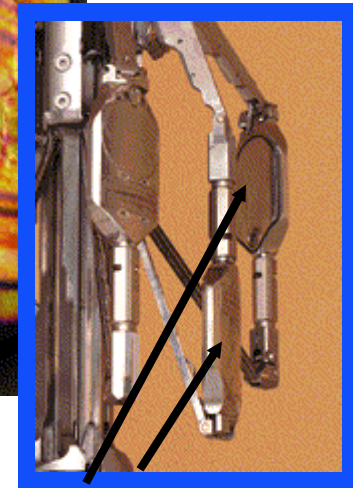
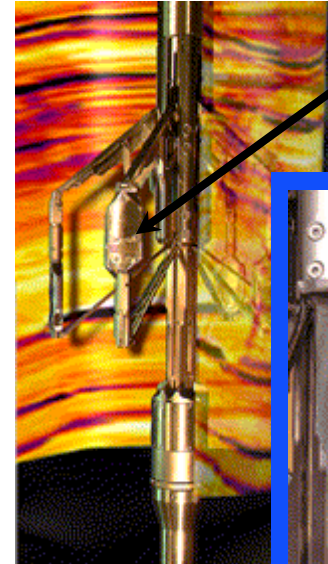

Alternate pads offset from each other



Courtesy of Paauwe, 2001

RESISTIVITY IMAGE COVERAGE

4 ARM 4 PAD

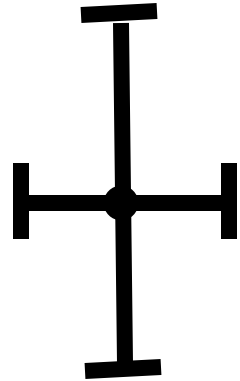

4 ARM 4 PAD 4 FLAP

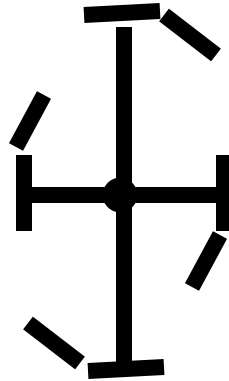

6 ARM 6 PAD

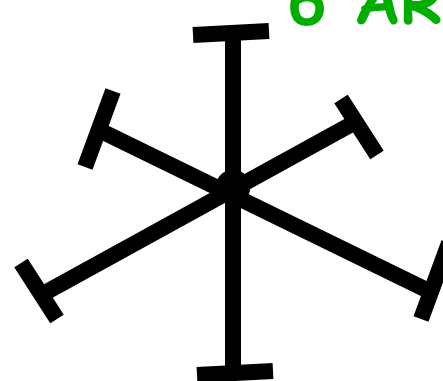

2-FMS

4-FMS

FMI

EMI/STAR

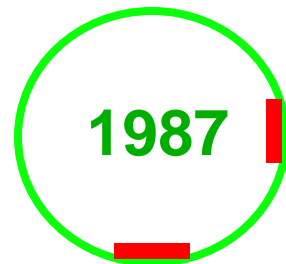

1987

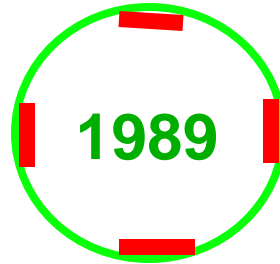

1989

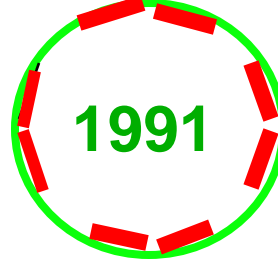

1991

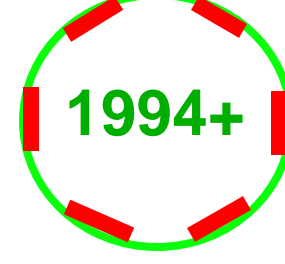

1994+

8.5" hole:

20%

40%

80%

60%

12.25" hole:

14%

28%

56%

42%

Oil based mud (OBM) imager

- Difficult to get current via OBM
- Resolution must be on formation scale
- Resistivity range must be large
- Imager must have higher lateral/vertical res.
- OBMI™ introduced 2001
- Cheung et al., 2001 paper

OBMI trademark of Schlumberger

OBMI™ functional diagram

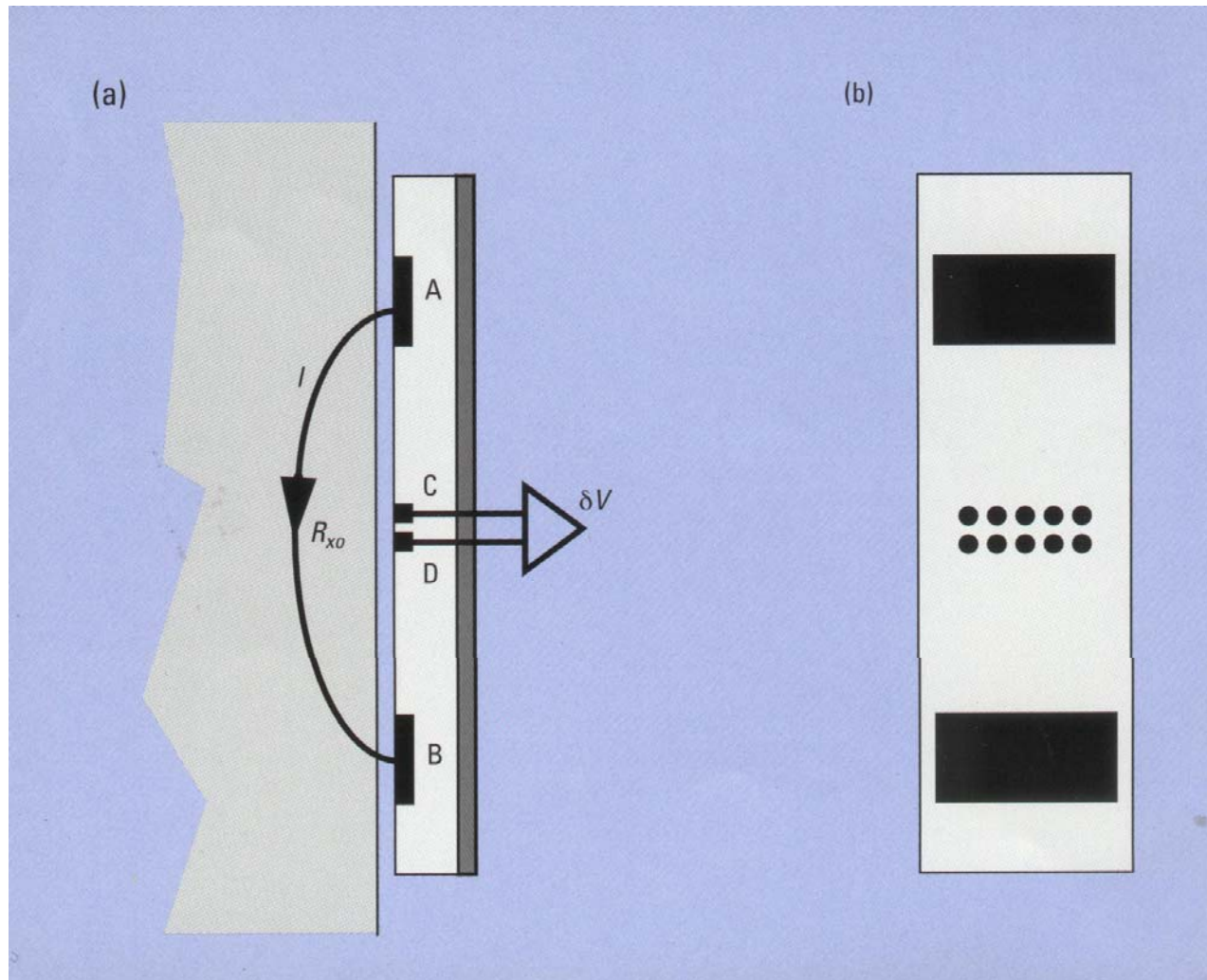

(Schlumberger OBMI,2002)

OBMI™ versus core image

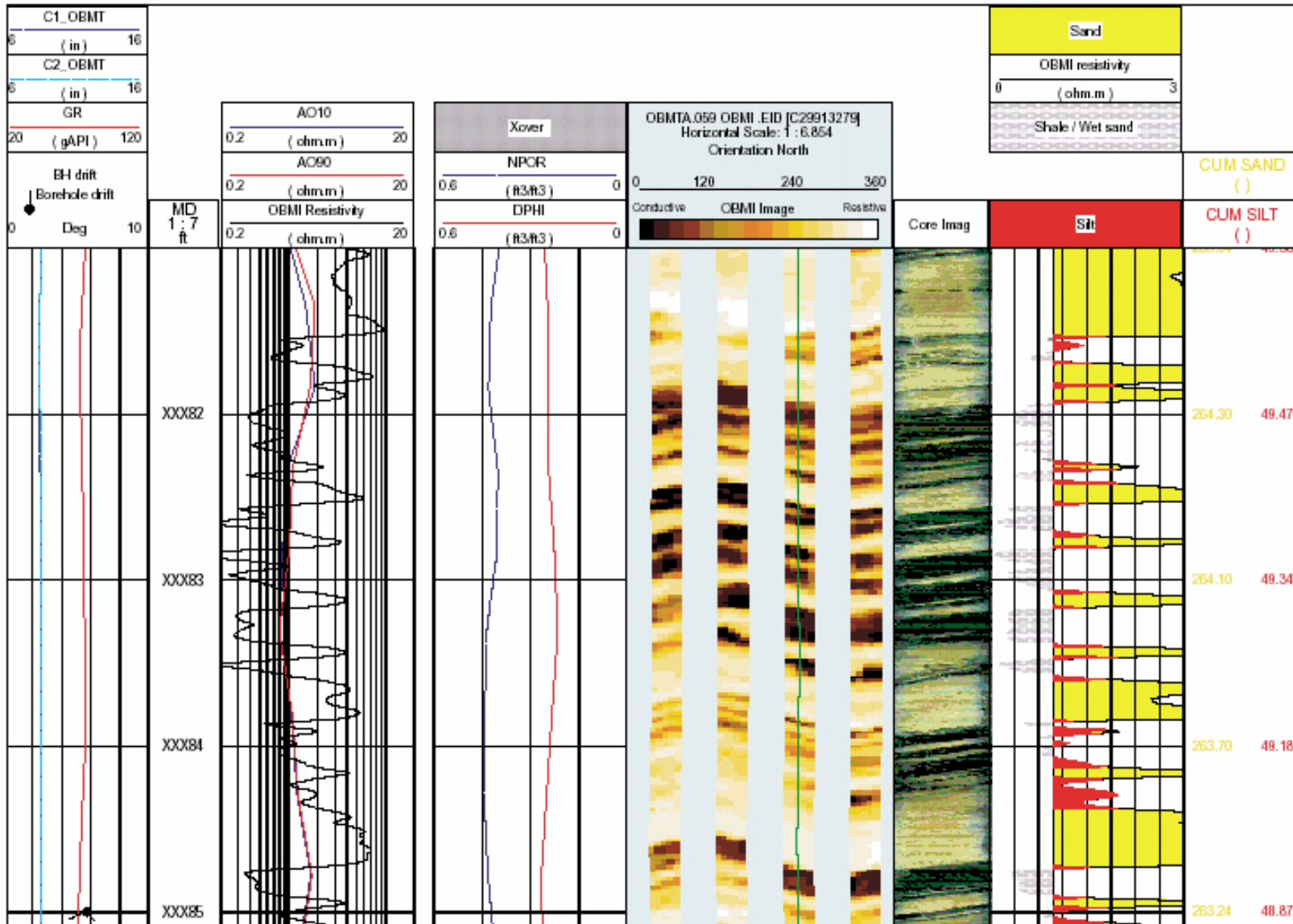

After Cheung et al., 2001

Array induction requirements

- Multiple depths of investigation
- Multiple vertical resolution (improved!)
- Increased depth of investigation
- More reliable measurements
- Streamlined interpretation

Resolution matched example

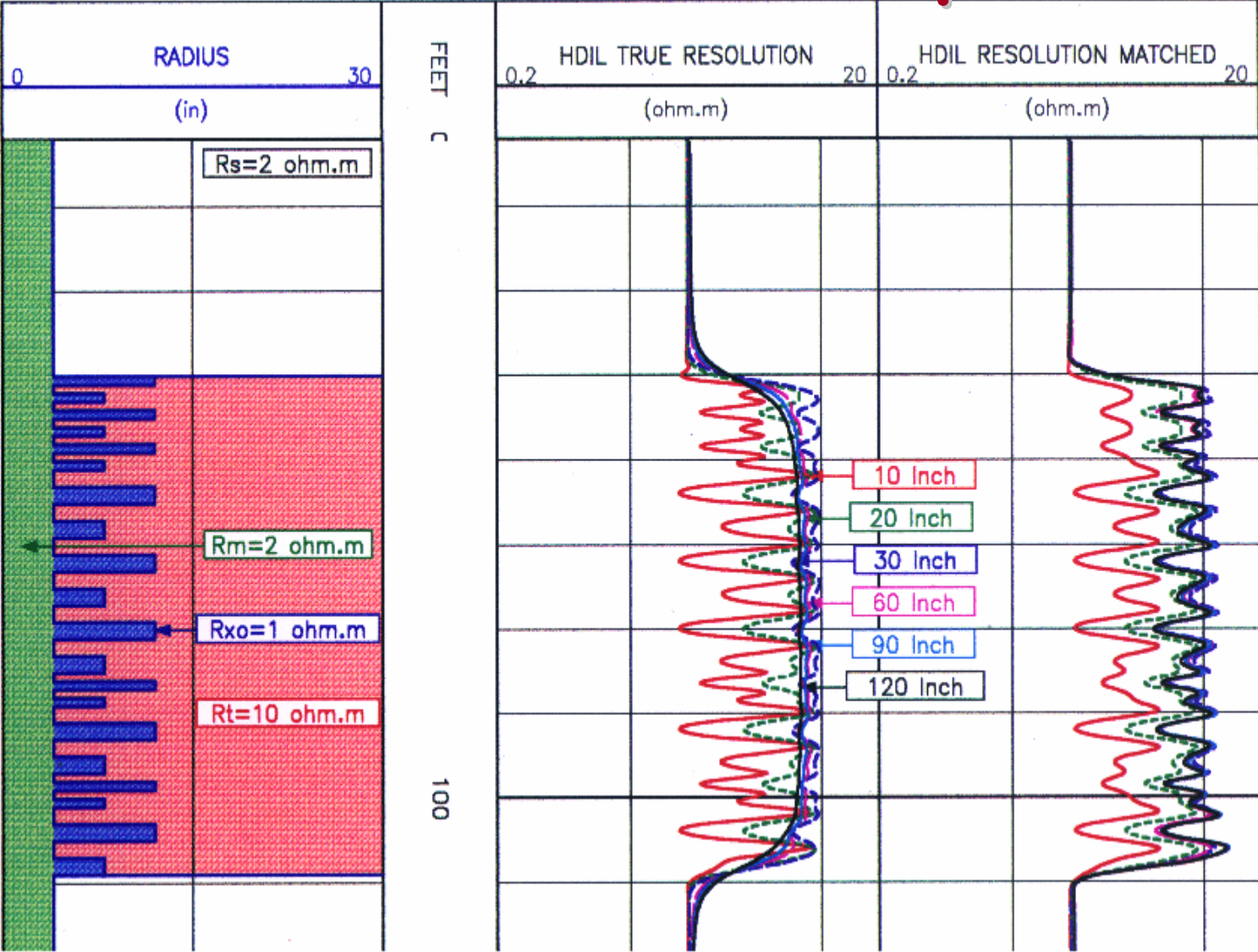

Array Induction: Dip Effect & Correction

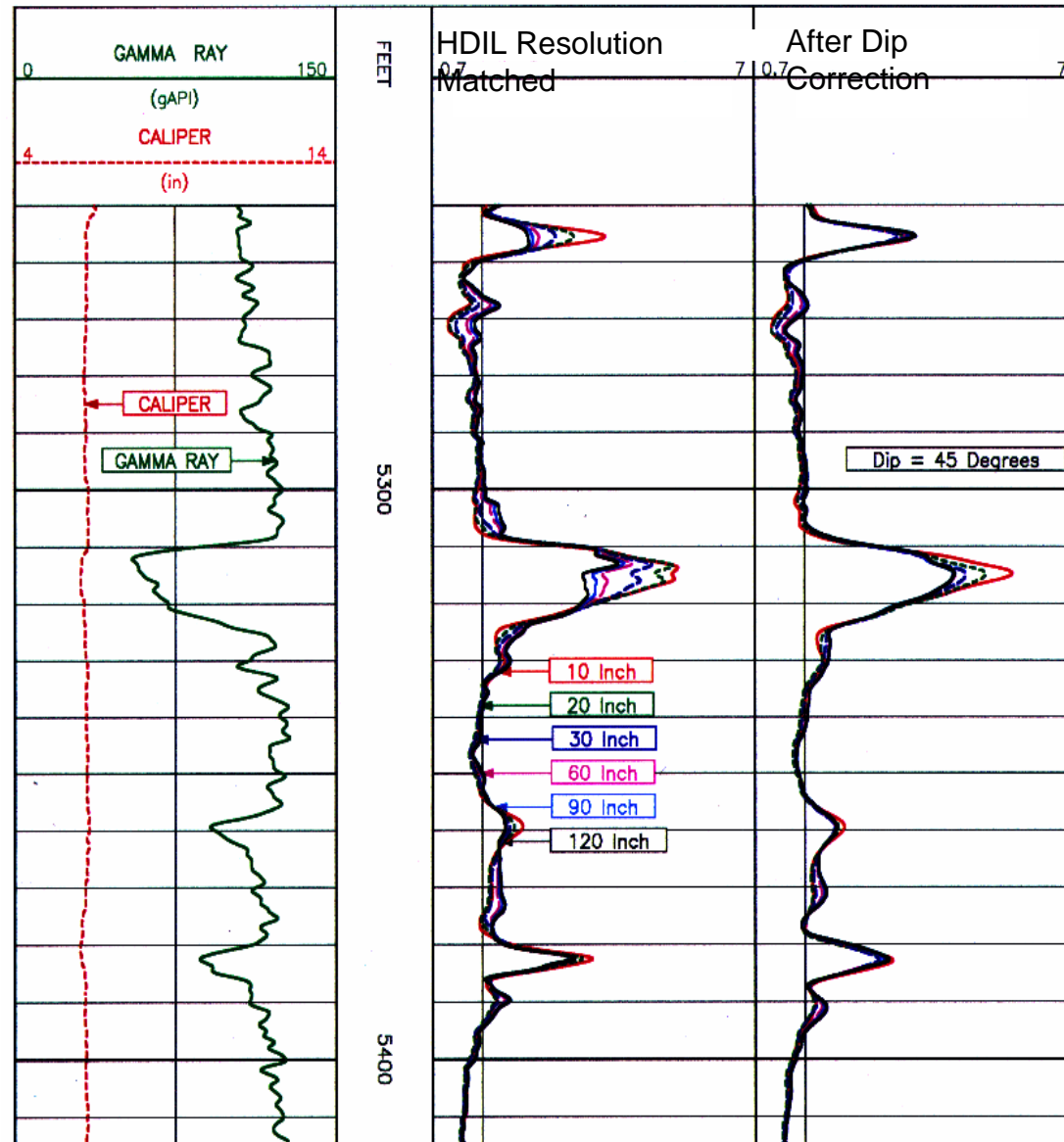

After Beard and Evans, 1996

Step change through hardware

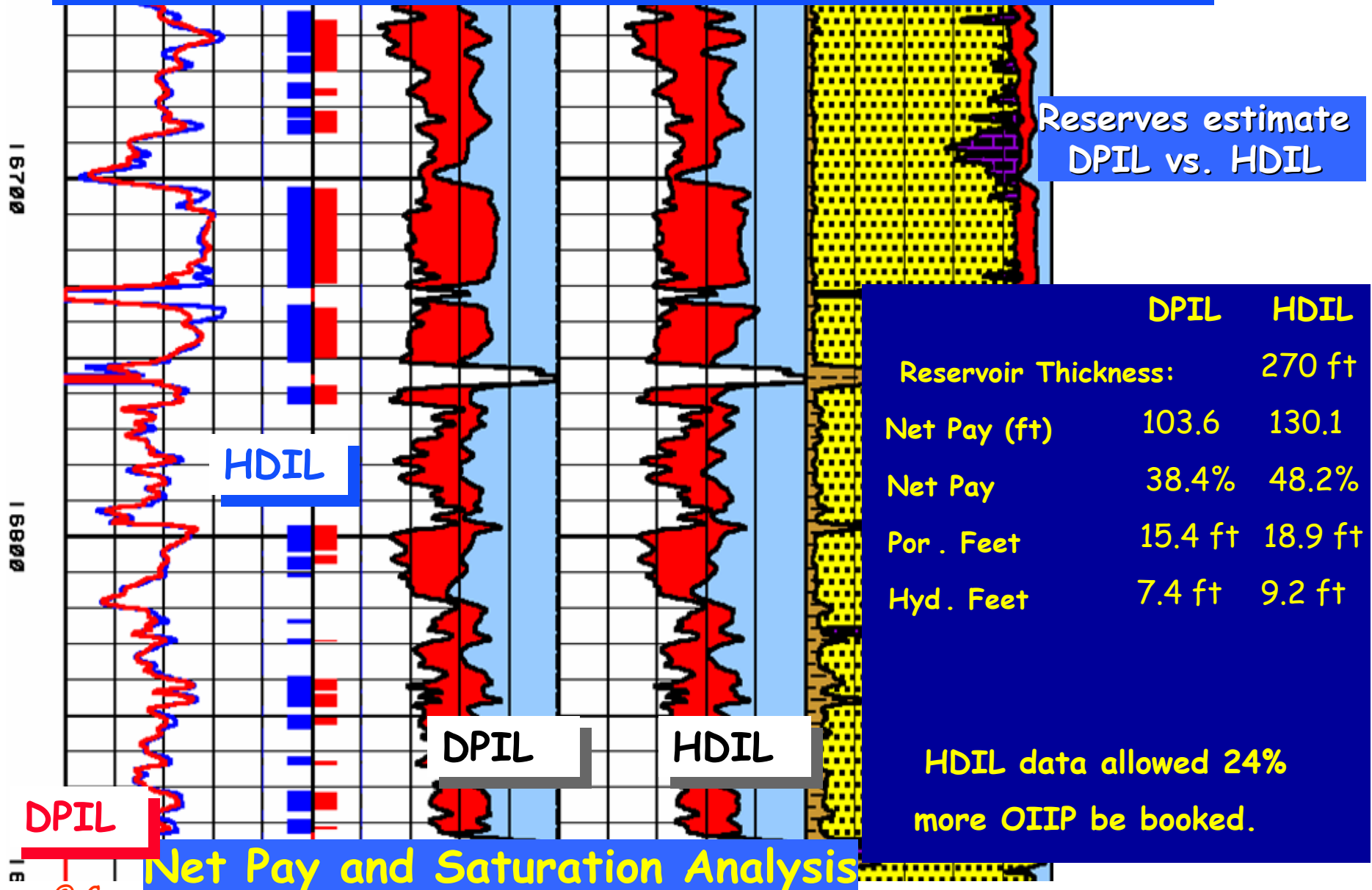

2 ft VRM vs 2D inversion

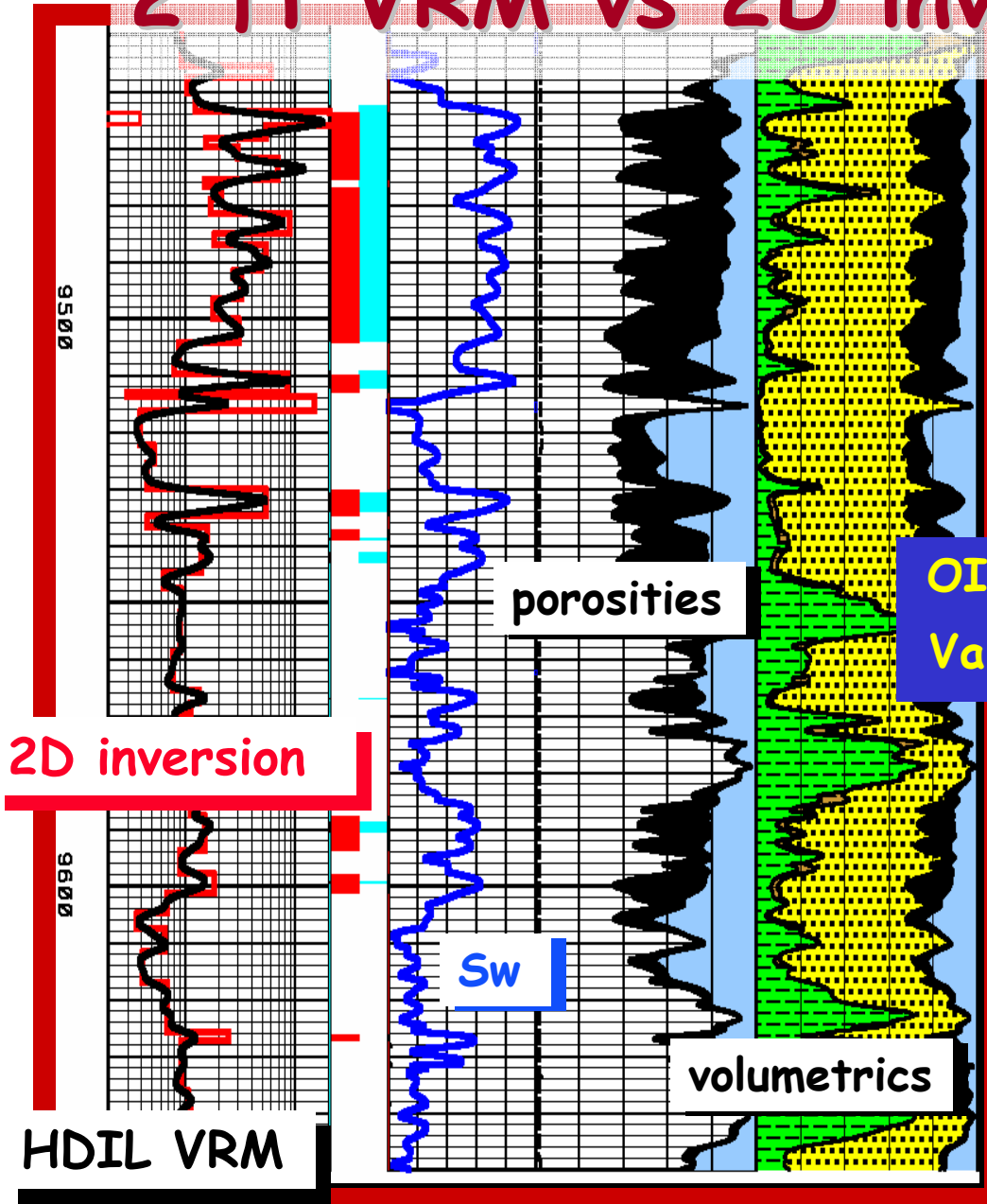

$$OIIP = (A \cdot h) \cdot Por \cdot (1 - Sw)$$

A = 160 acre

Assume 7,758 API Bbl/acre-foot

1 Bbl = \$22

OIIP	14,912,427 Bbl	16,173,193 Bbl
Value	328 M\$	356 M\$

2 ft VRM Curves

2D Inversion

h 67.00 ft
 Por 25.8%
 (1-Sw) 69.5%

74.75 ft
 25.9%
 67.3%

Array laterolog objectives

- Next generation lateral instrument
- Resolve
 - ⊗ thin beds (< laterolog- 2ft)
 - ⊗ deep invaded formations
- Provide accurate radial profile of R_+ & R_{x0}
 - ⊗ invasion & flushed zone evaluation
- Provide risk analysis input
 - ⊗ error bounds, parameter importance

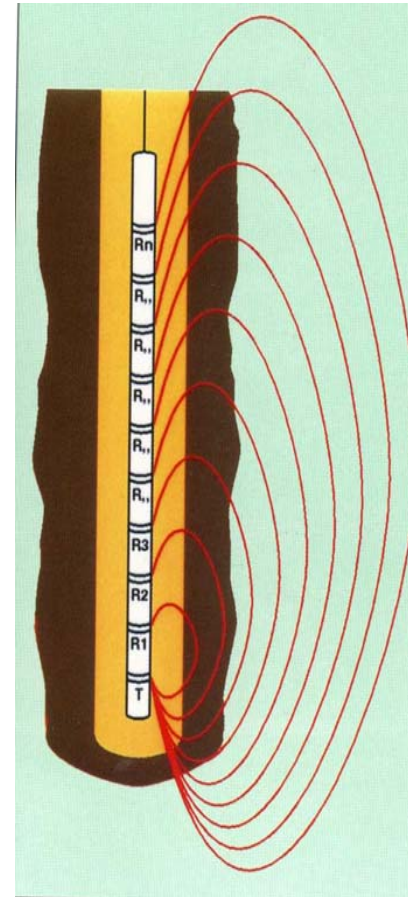

HDLL versus DLL

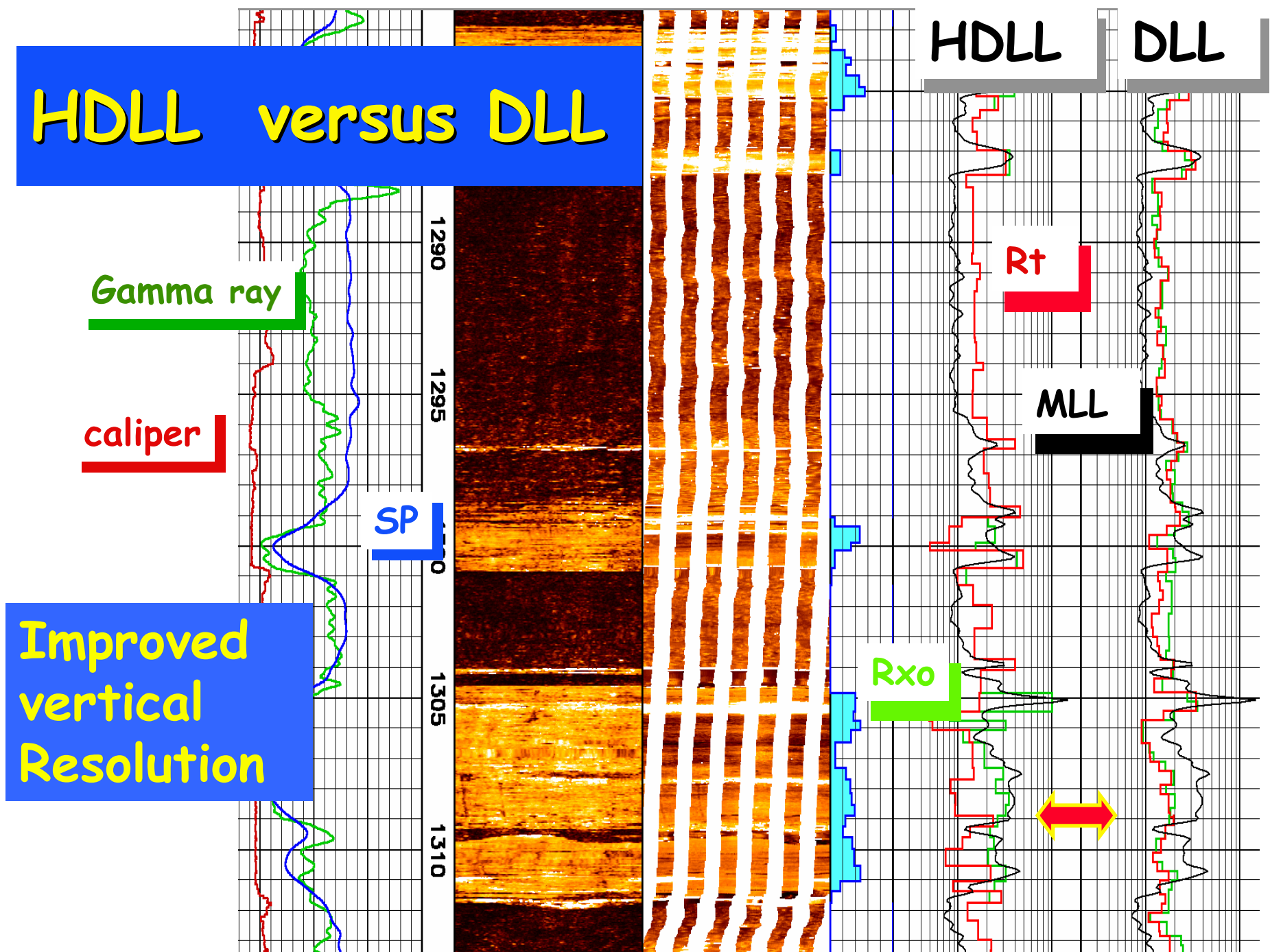

Improved vertical Resolution

HRLA Principle and Modes

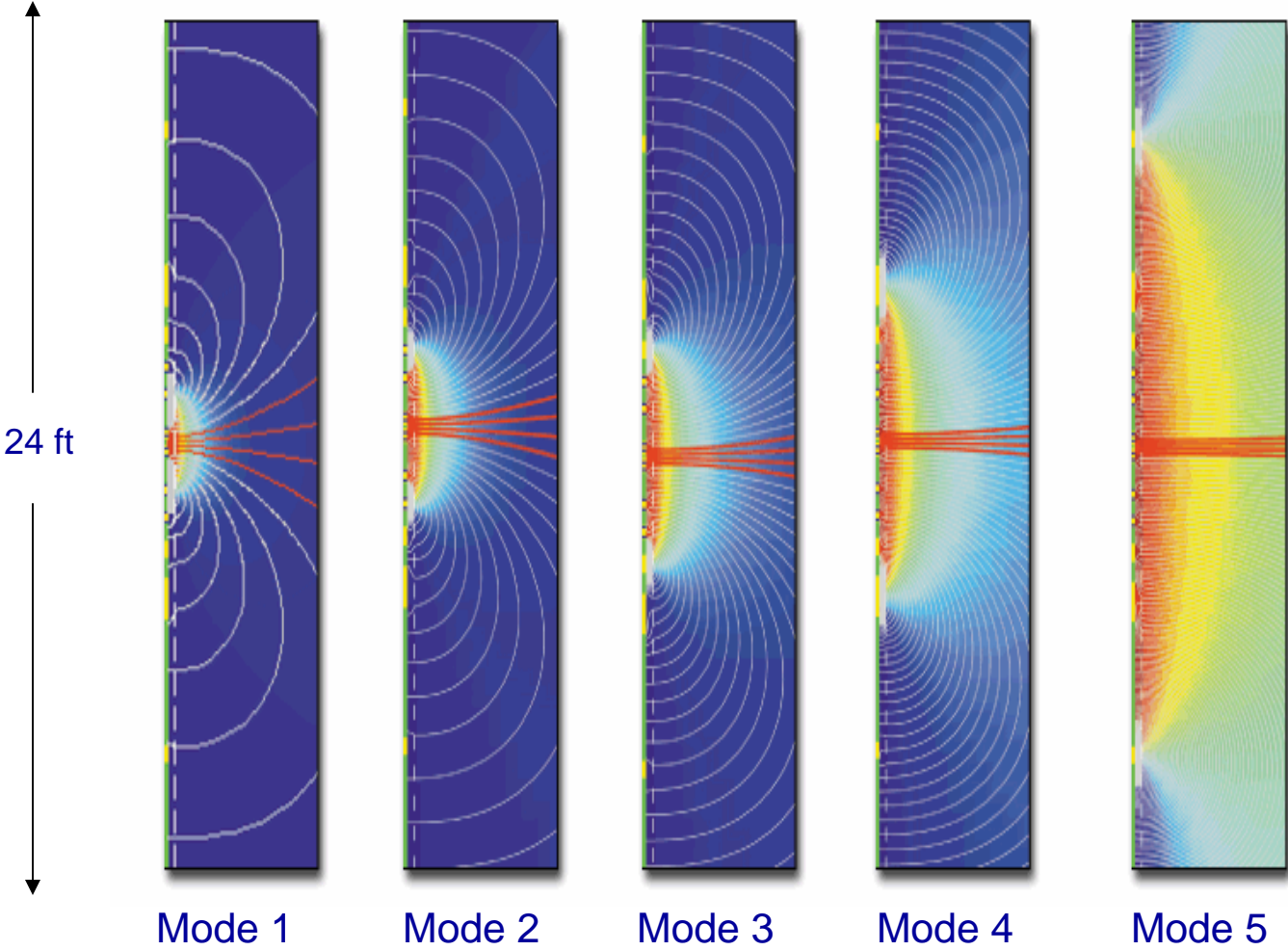

Courtesy of Barber, Schlumberger, 2001

Field Logs

- Main pay zone
- Gas sand
- Channel sand environment
- 8.5-in. bit
- $R_m = .08 \text{ Ohm-m}$

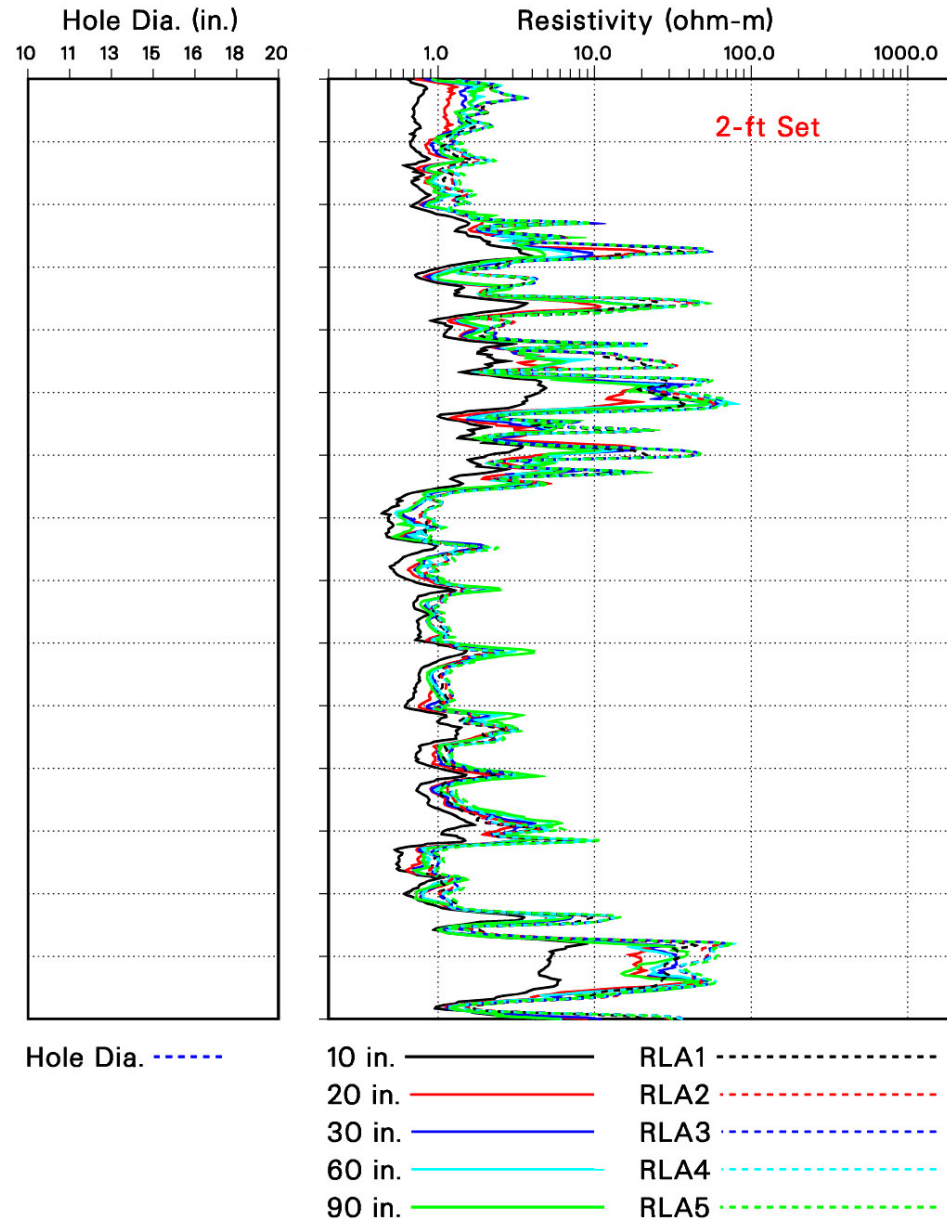

Courtesy of Barber, Schlumberger, 2001

Resistivity logging: Past, Present & Future

- Introduction
- Past
 - ☒ History
 - ☒ Older tools
 - ☒ Pitfalls
- Present
 - ☒ Overall concept
 - ☒ Improved tools
 - ☒ Innovative tools
 - Azimutal image
 - 3D induction
 - Through Casing Resistivity
 - ☒ Interpretation
- Future

Azimuthal resistivity imager (ARI™)

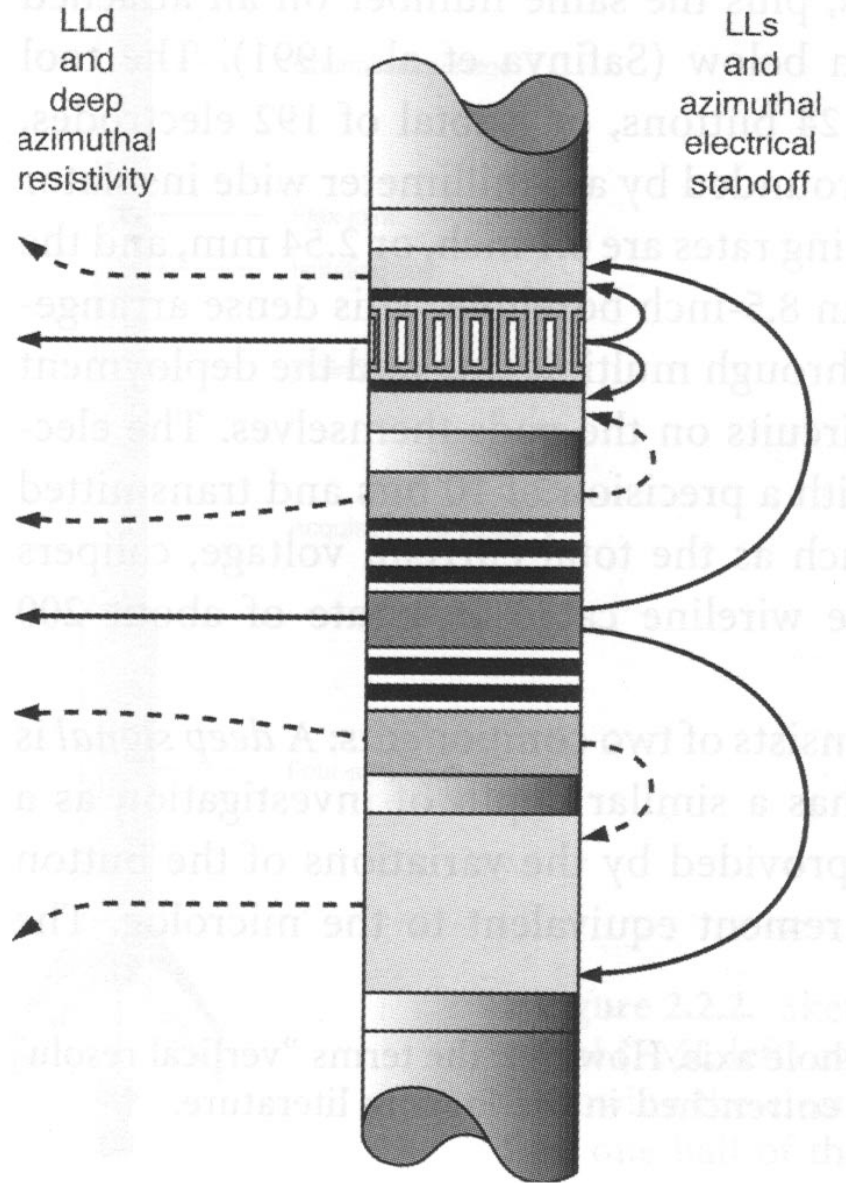

After Luthi, 2001

ARI™ example

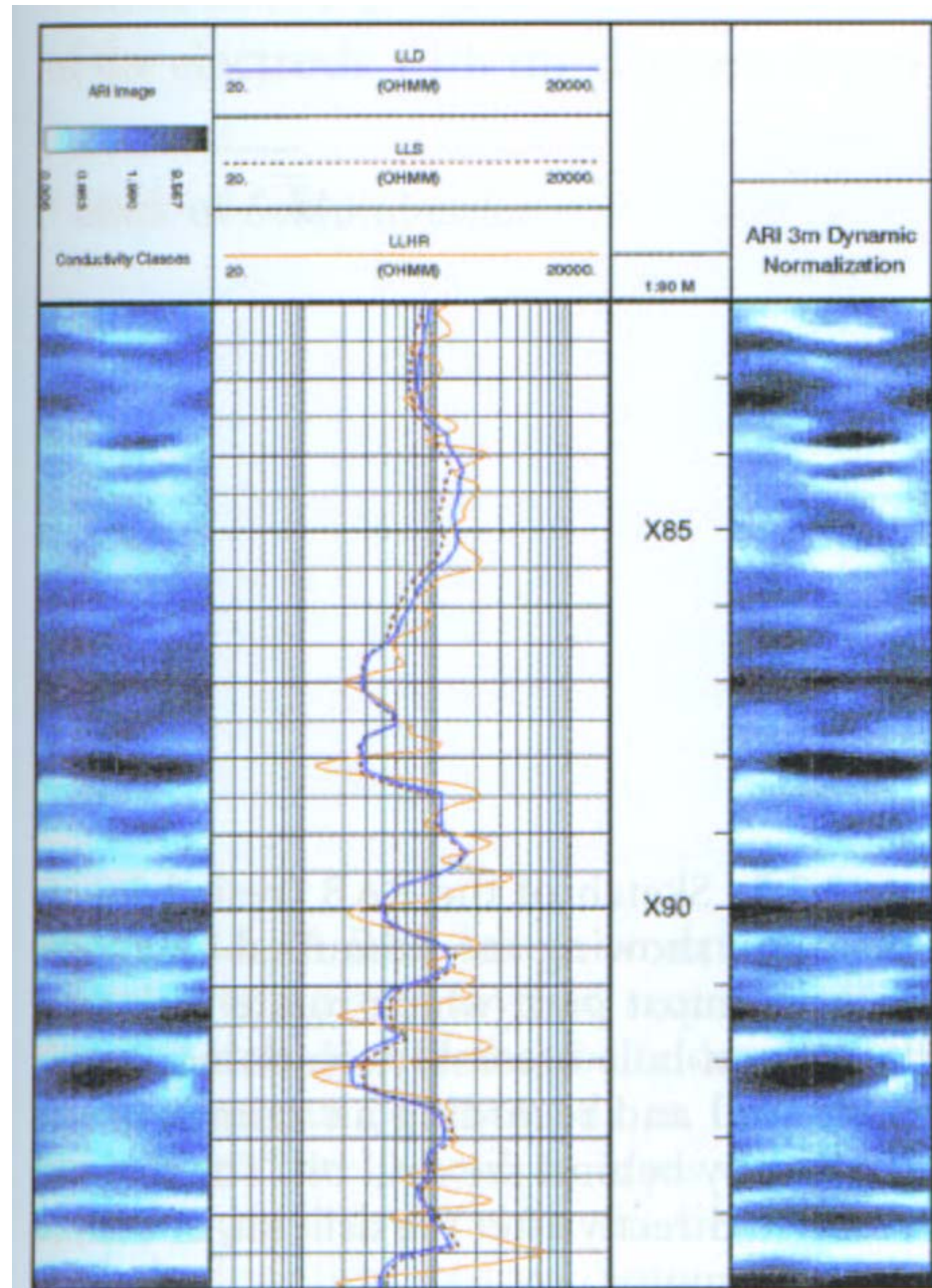

After Luthi, 2001

ARI™ detailed example

After Luthi, 2001

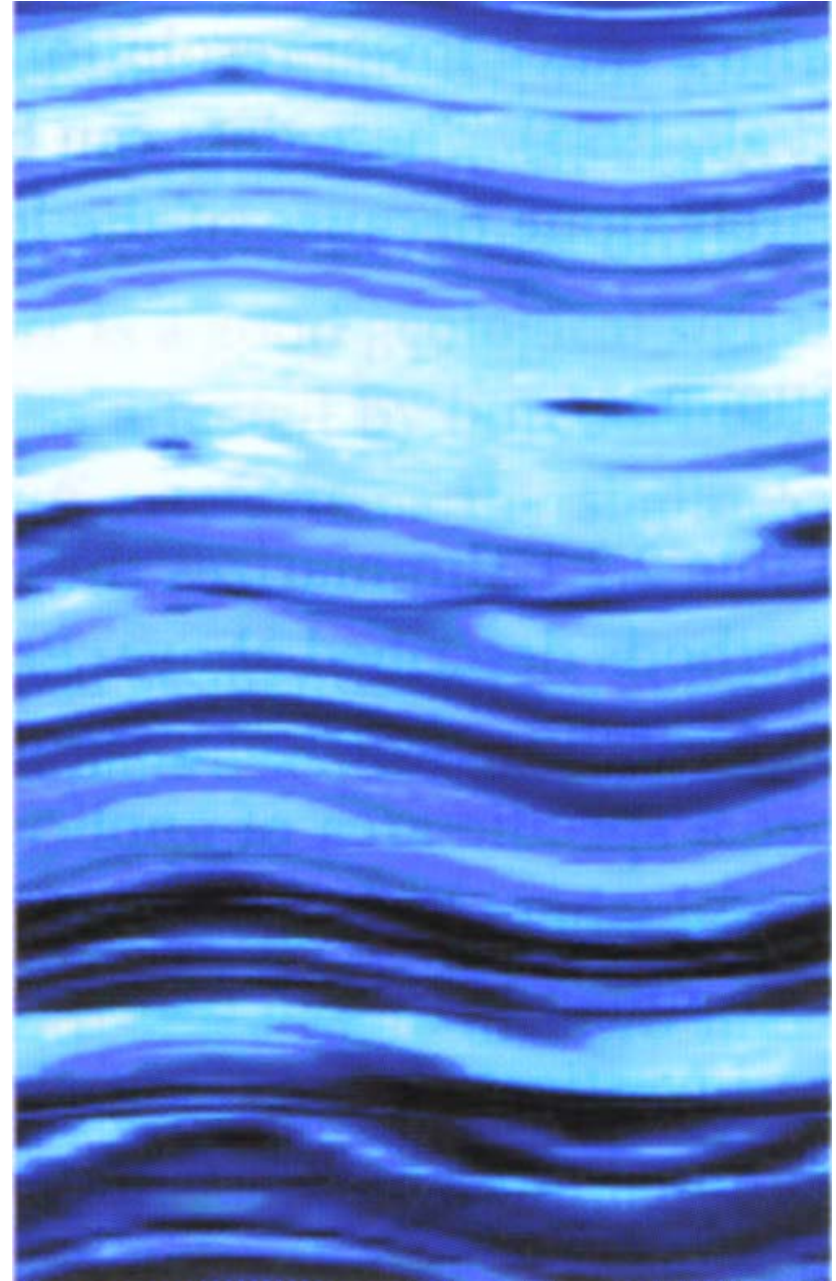

© Copyright KJT Enterprises Inc. 2001-2004

Resistivity tools

- Laterologs
- Induction logs
- Thin bed tools
- Azimuthal resistivity imager
- Relationship to image tools
- **Through casing resistivity**
- 3D induction
- Inversion of resistivity logs

TCRL™: Benefits

- Bypassed hydrocarbons
- Monitor reservoir changes with time
 - ☒ water/gas flood control
- Better reservoir estimates
 - ☒ larger depth of investigation
 - ☒ optimized vertical resolution

Strack, 1999

Basic history

- Three electrode scheme
 - Modern design
 - WA feasibility study
 - Colorado test
 - PML acquisition by BA
 - First digital log, BA Texas
 - SLB commercial service
 - BHI cancel project
- Alpin (1939)
 - Kaufman (1990)
Vail (1991)
 - May-Nov. 1993
 - Dec. 1993-Mar. 1994
 - Q4 1997
 - 5/98
 - 1999
 - 2000

Strack, 1999

TCRL principle of operation

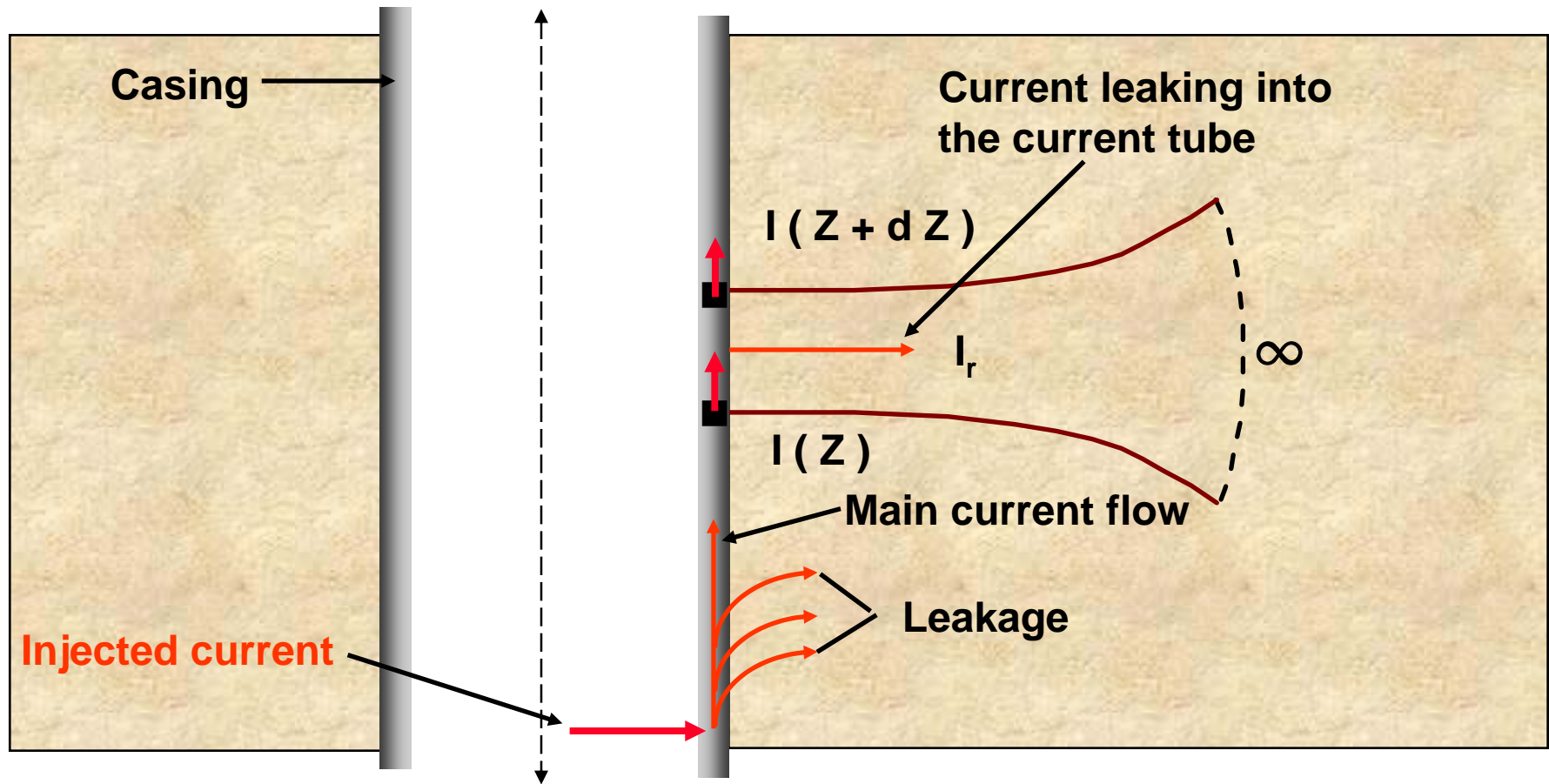

Strack, 1999

Operational modes

Reference

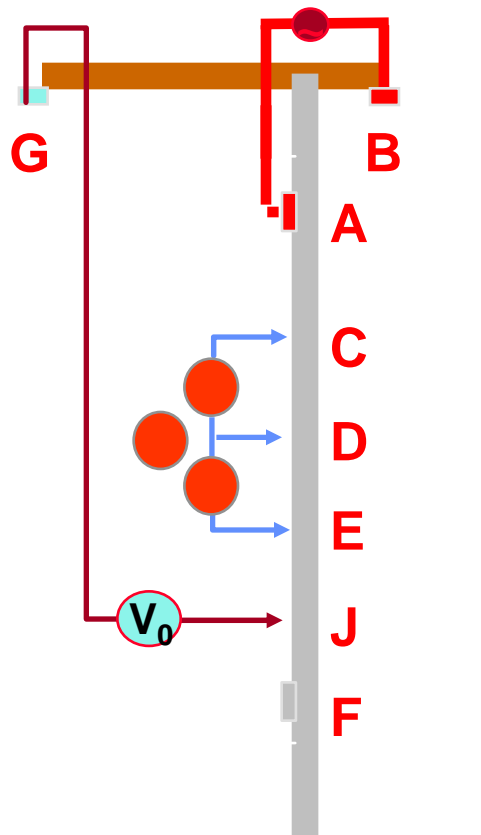

Calibration

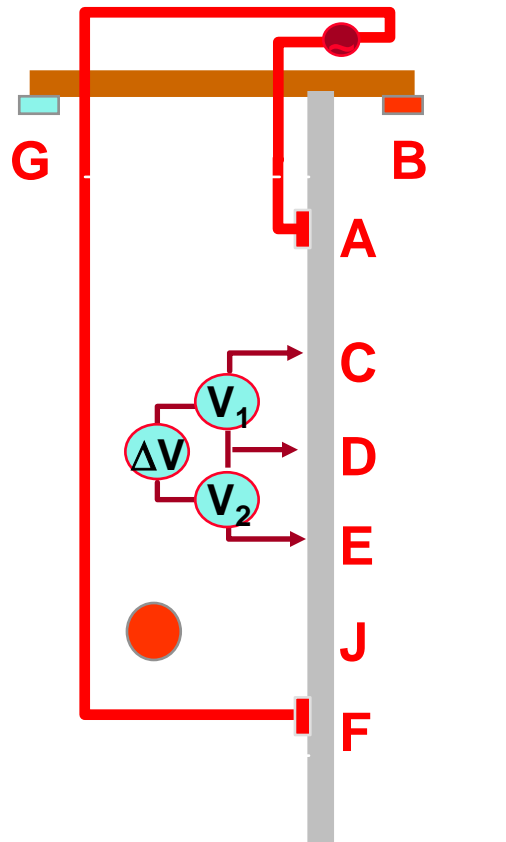

Measurement

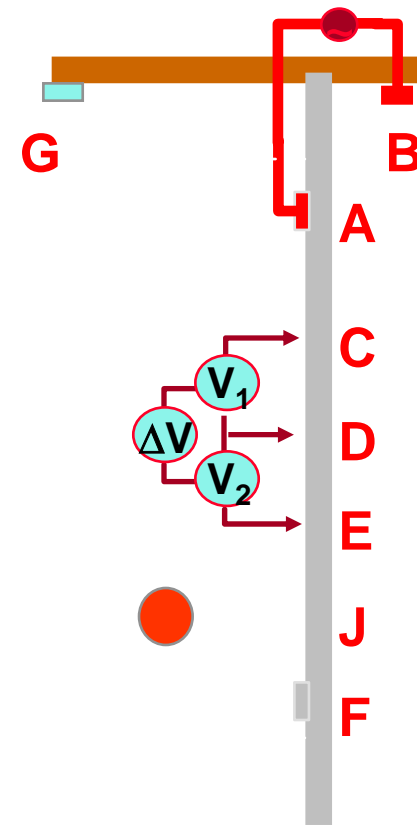

Strack, 1999

TCR tools at Baker Atlas test well



SLB: measurement & calibration

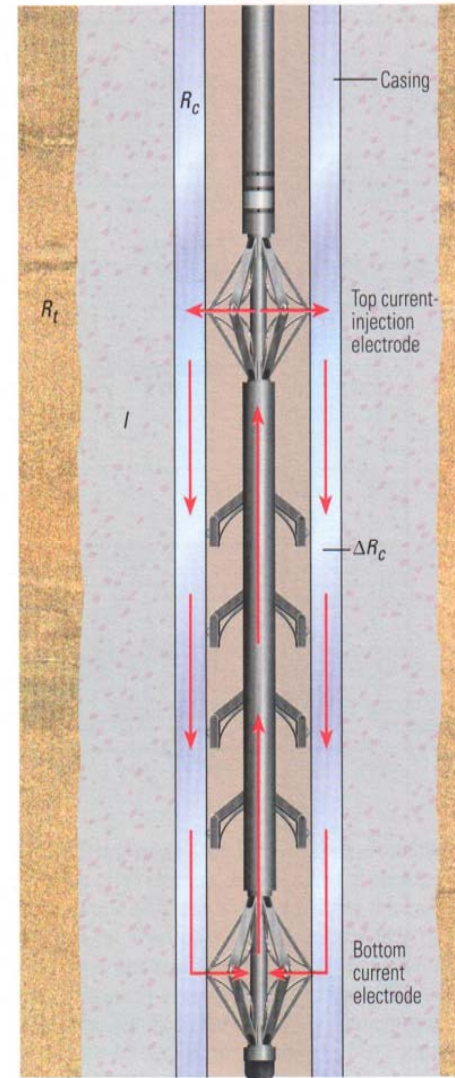
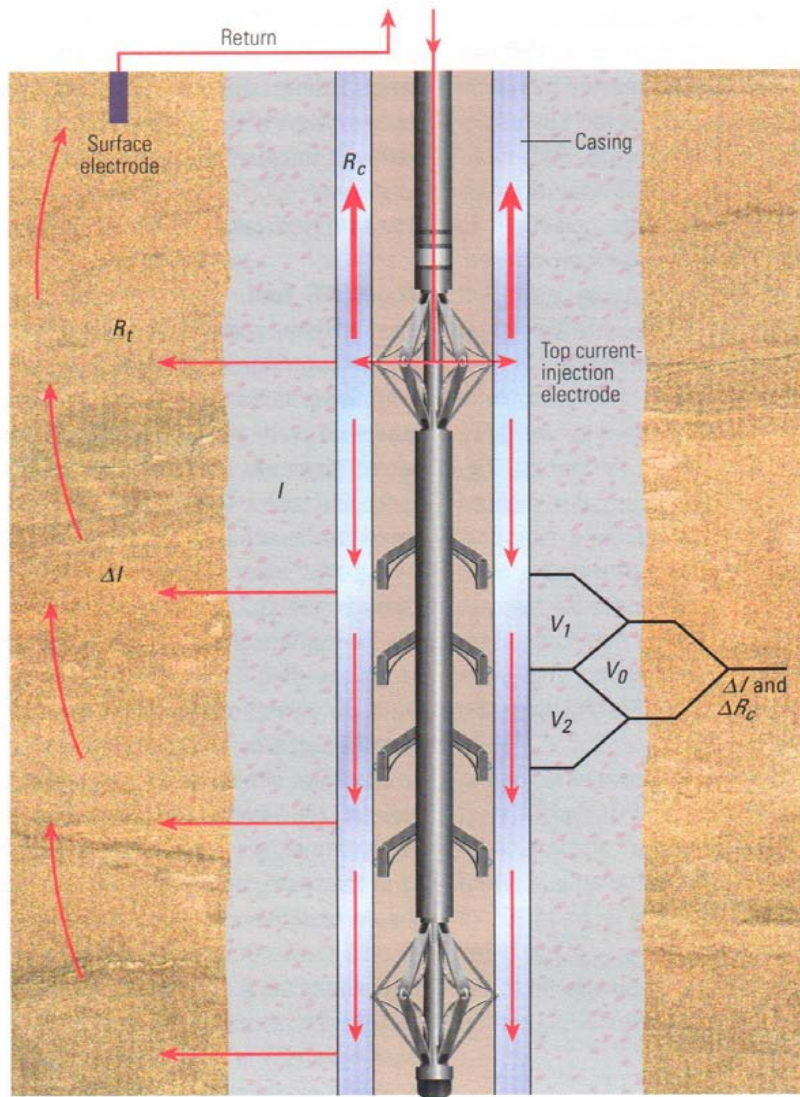

(Aulia et al., 2001)

Casing shoe & reservoir depletion

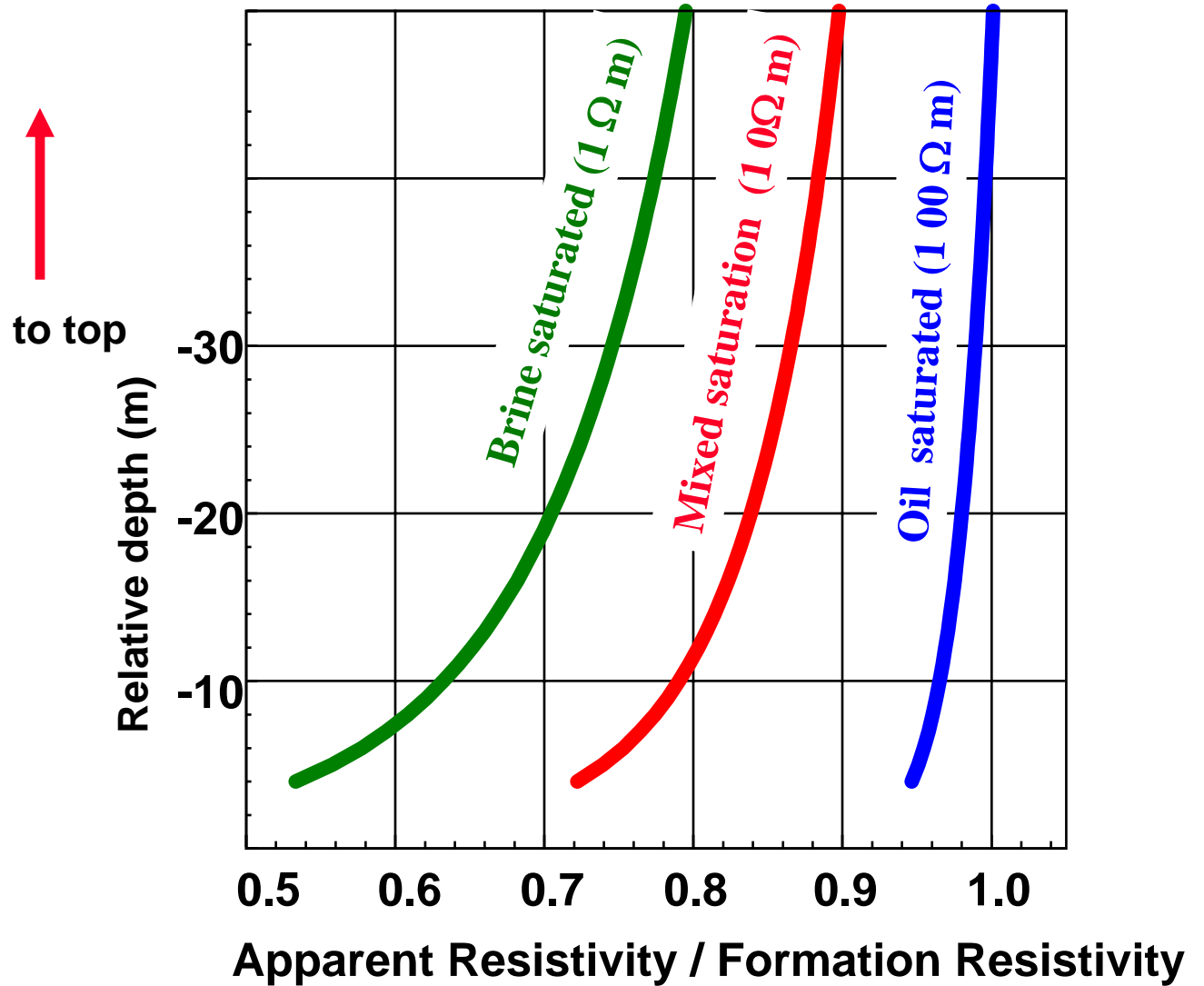
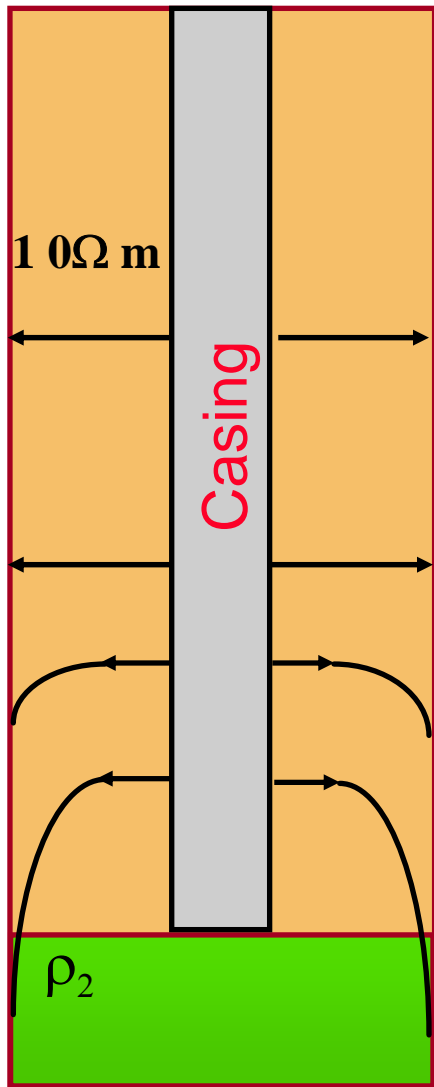

Casing collar effect (resistive)

Feasibility Study

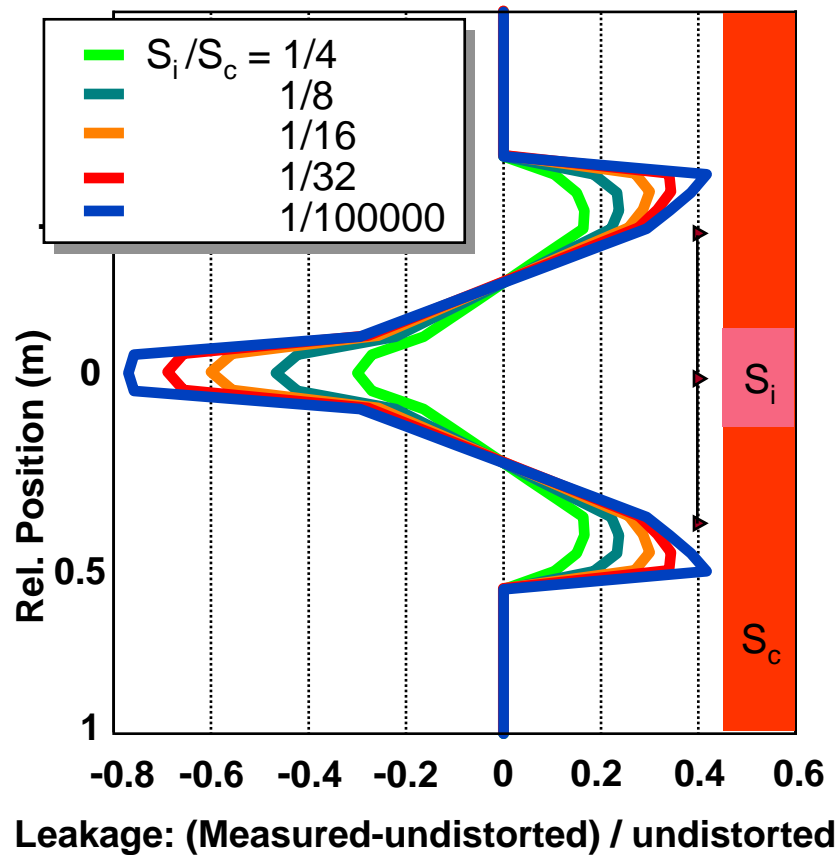

[Link to original field plot](#)

Test well

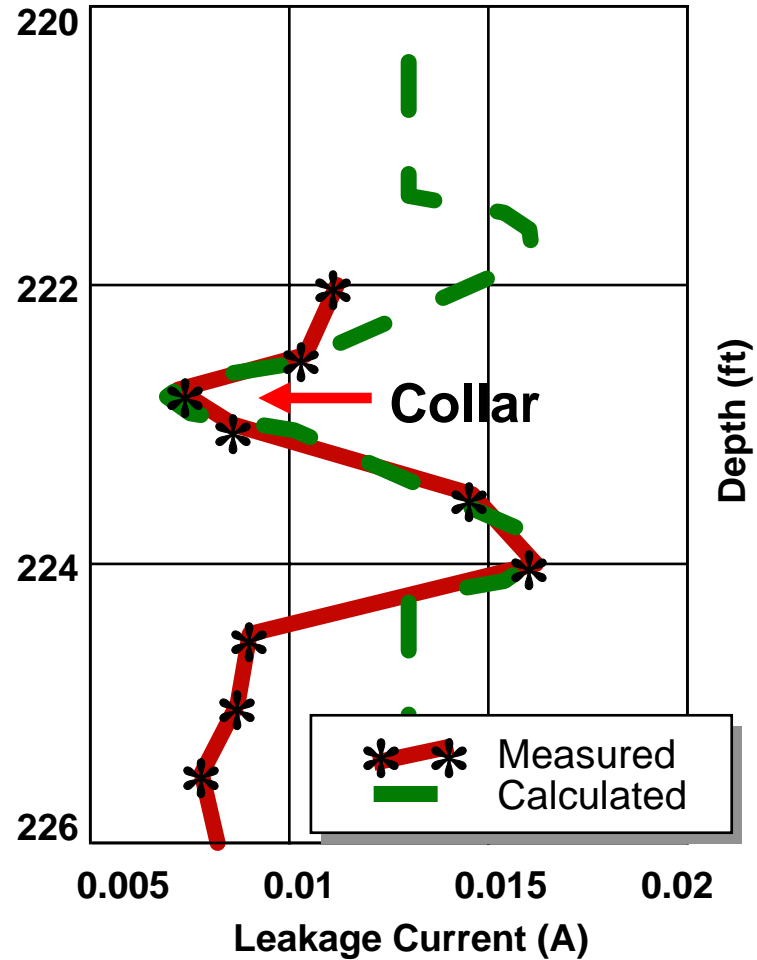

Strack, 1999

Colorado test: Blind test zone

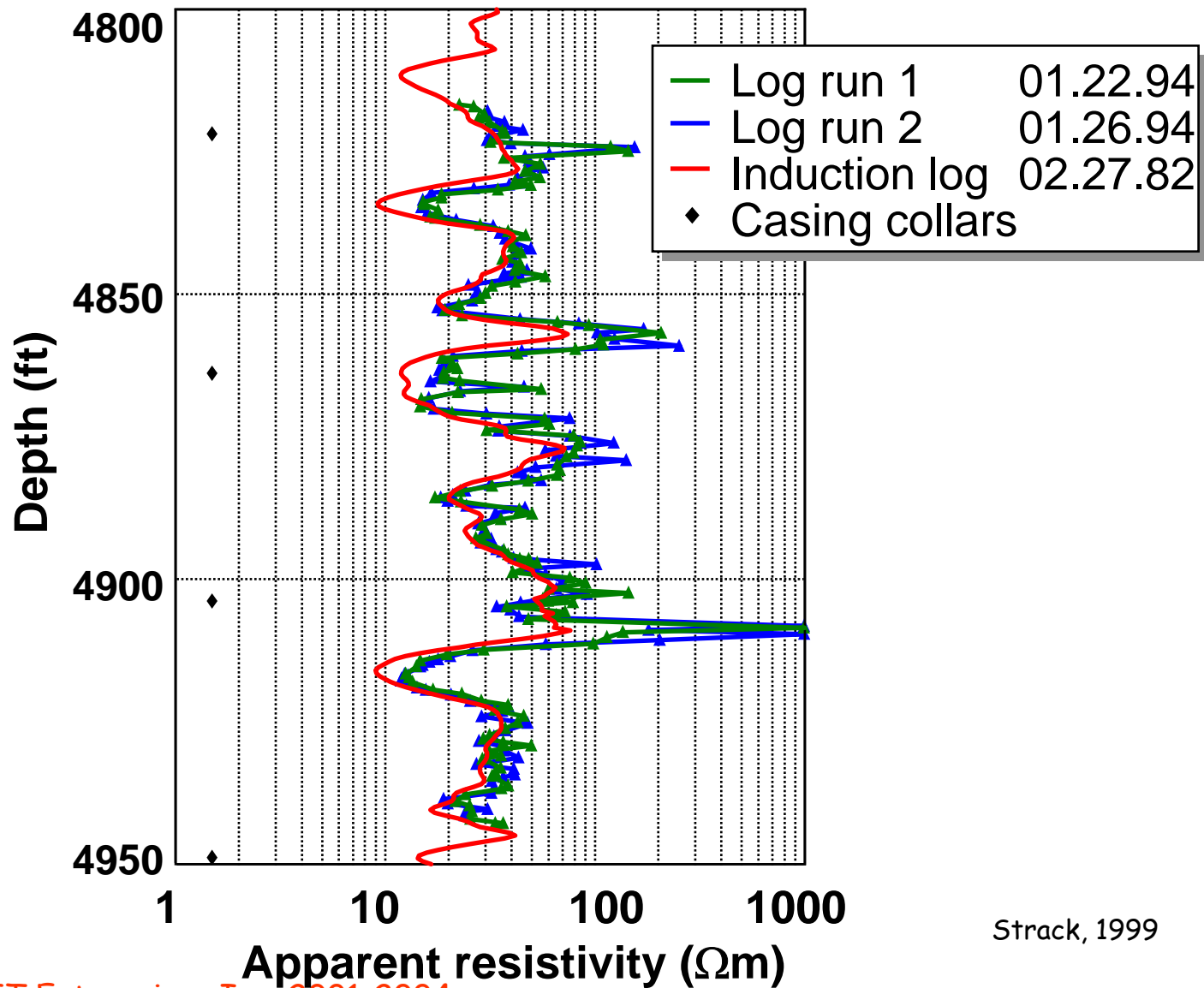

TCR™ versus CHFR™

After Qiang et al., SPWLA 2002

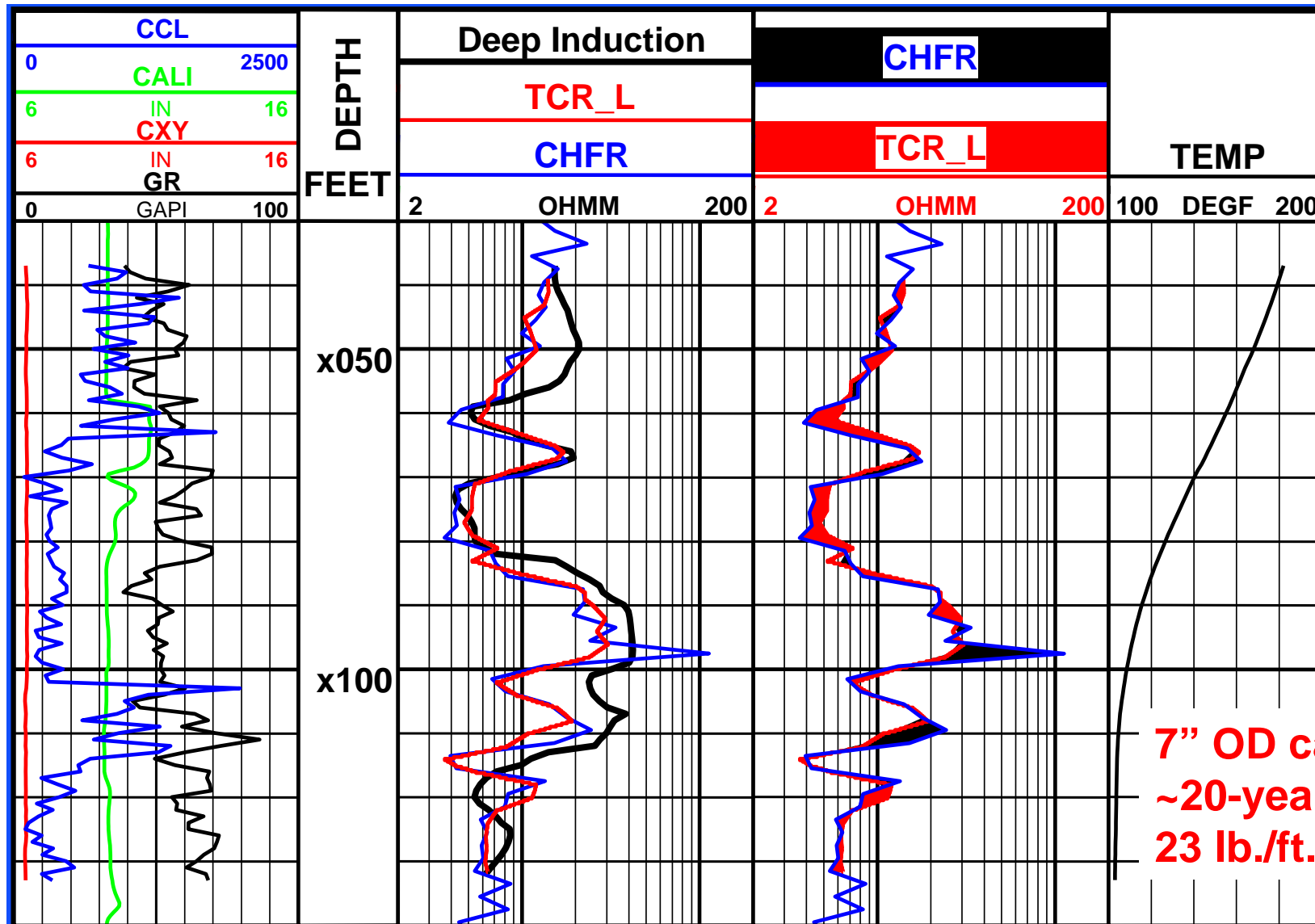

Summary: TCR™

- TCR works: Schlumberger have working tools
- Numerical modeling predicted results
- It took 60 years from idea to tool
- Better commercial tools are still needed

After Strack 1998

Transverse Induction - history

- Problem long known (Gianzero, Anderson, Klein & Allen etc)
- Commercial values recognized by Shell (1991)
 - ✘ 20 - 30% missed reserves
- Project concept developed Shell/WALS 1992/93
- Shell funded development by Baker Atlas
- Shell patents: Beard et al., 1998 - WO 98/00733; Strack et al., 2000 - # 6147496
- First TILT tool runs GOM, Oman 1999, name changed to 3DEX™
- SLB's equivalent tool 2003

Crossbeds & sand/shale & siltstones

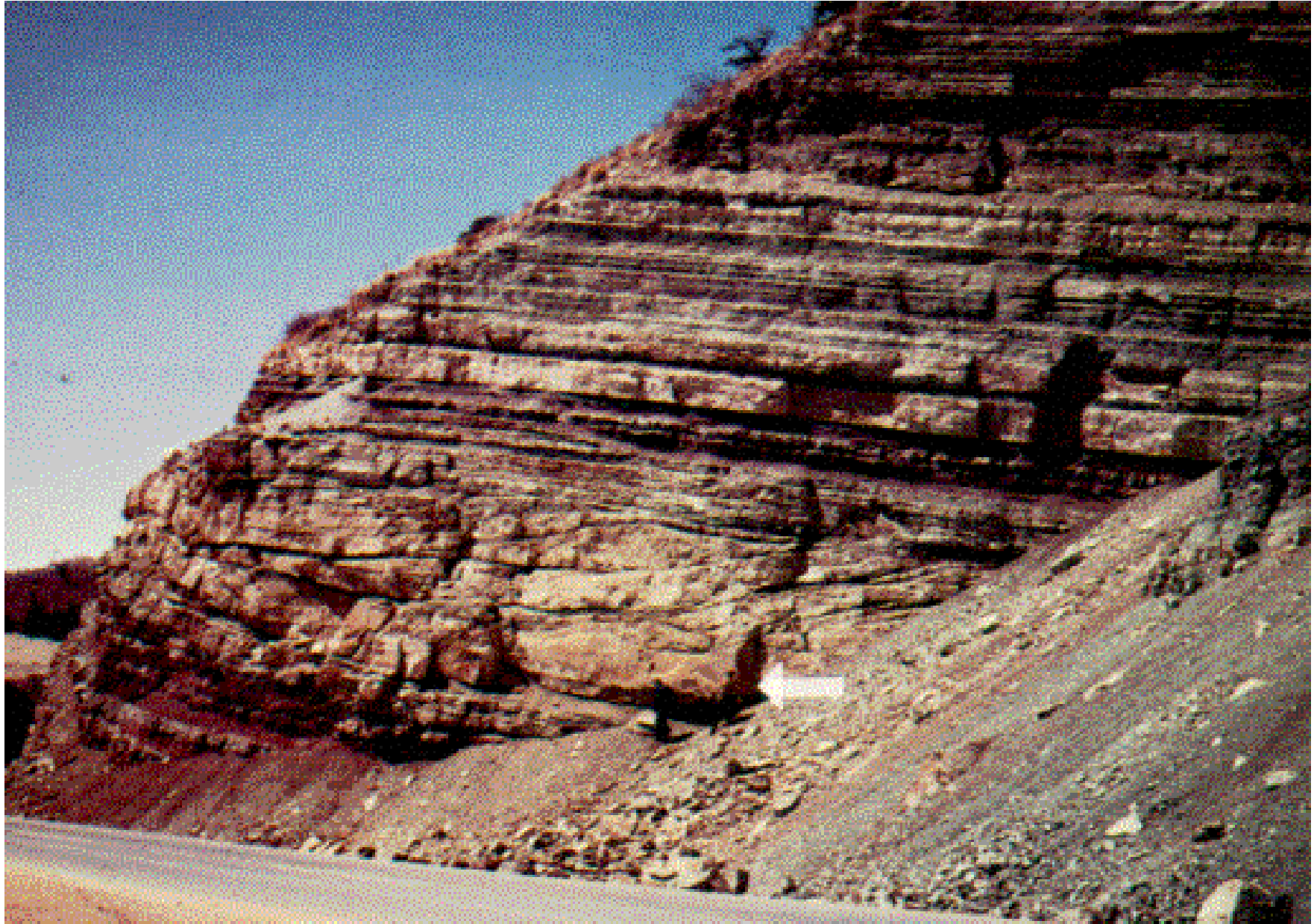

© Copyright KJT Enterprises Inc. 2001-2004

After Strack & Kriegshaeuser, 1999

Resistivity: example

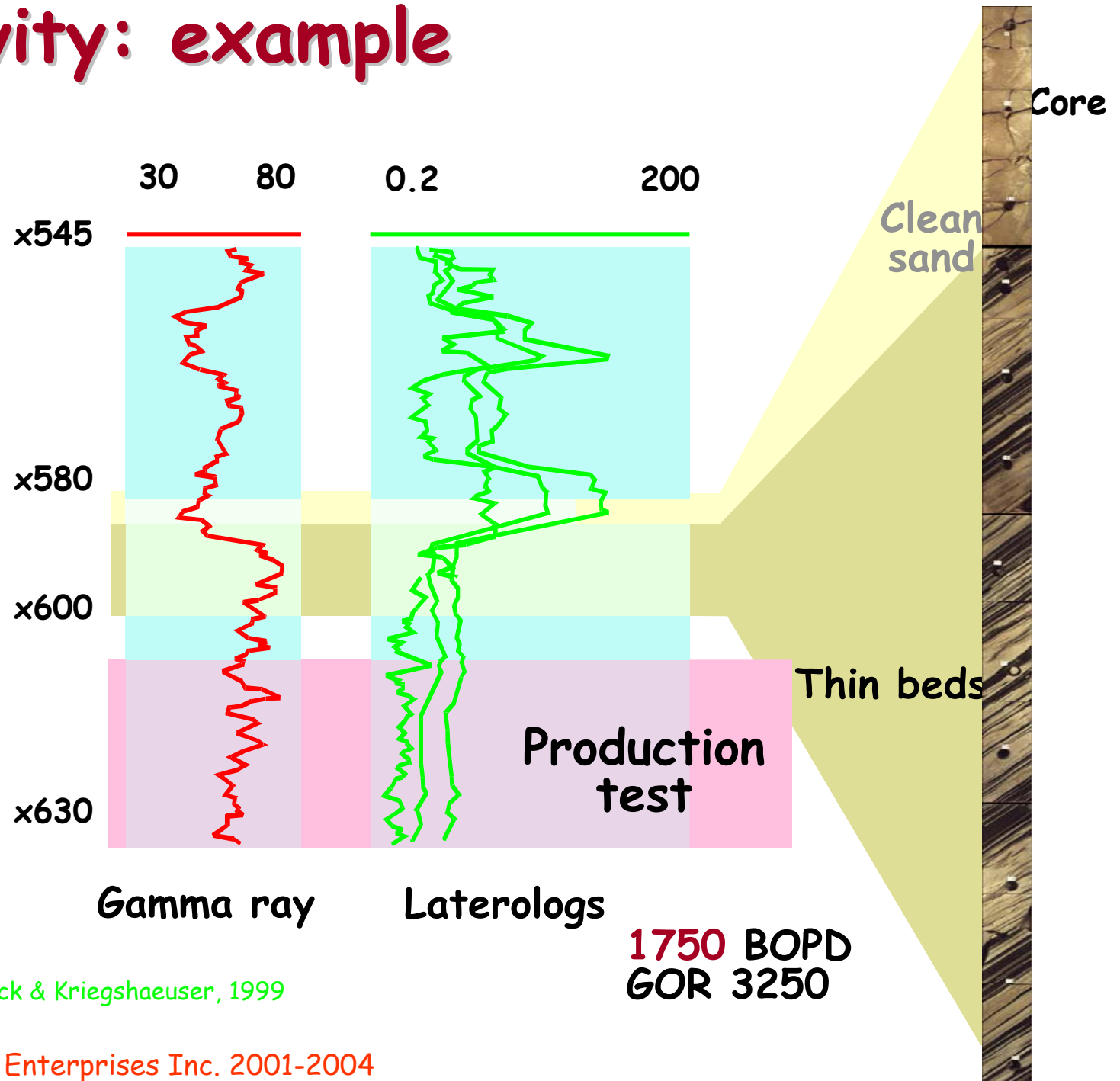

After Strack & Kriegshaeuser, 1999

Turbidite example



After Blackburn & Thomson, 2000

Transverse Induction logging principle

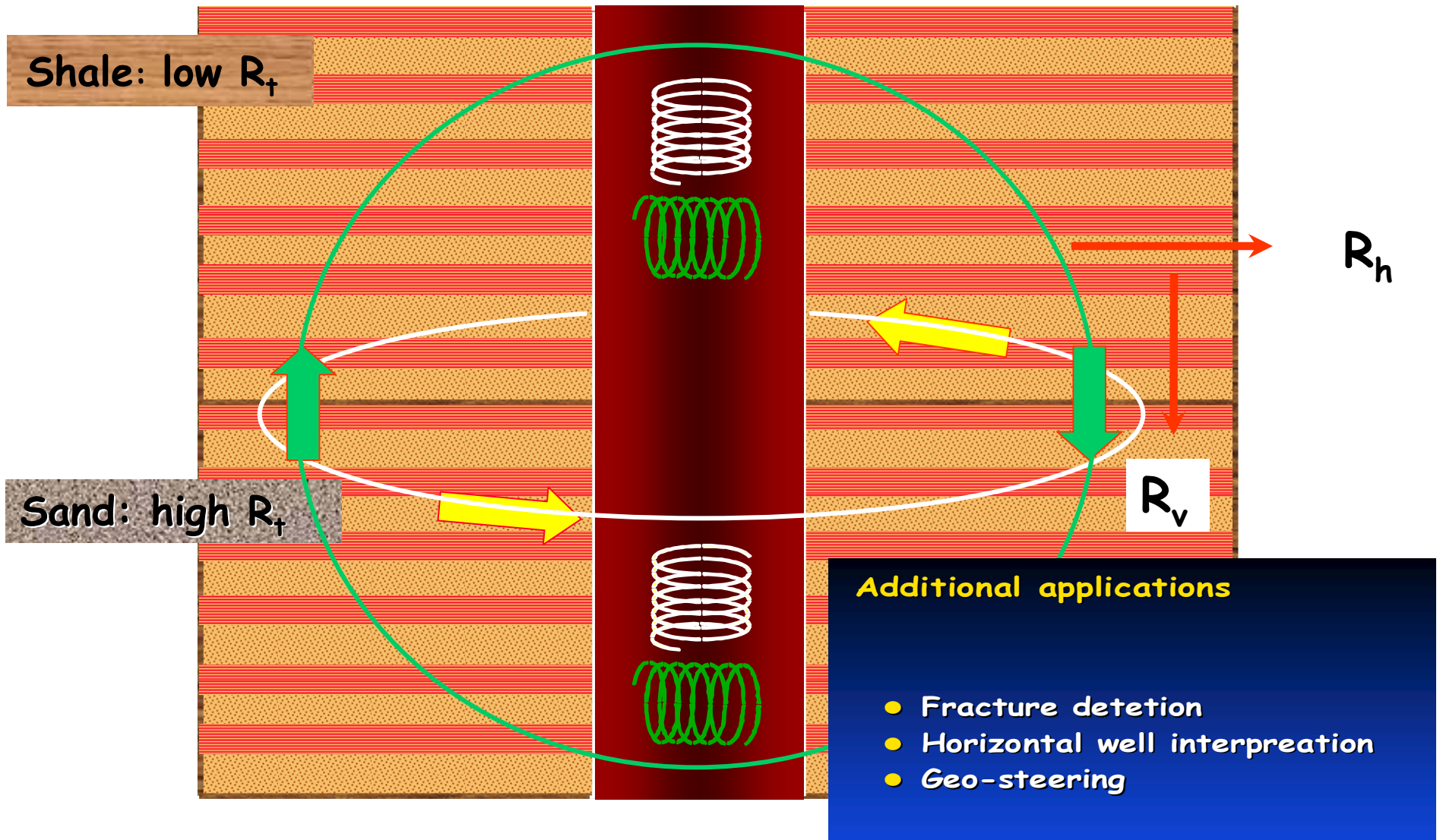

Resistivities in laminar Sand/Shale sequences

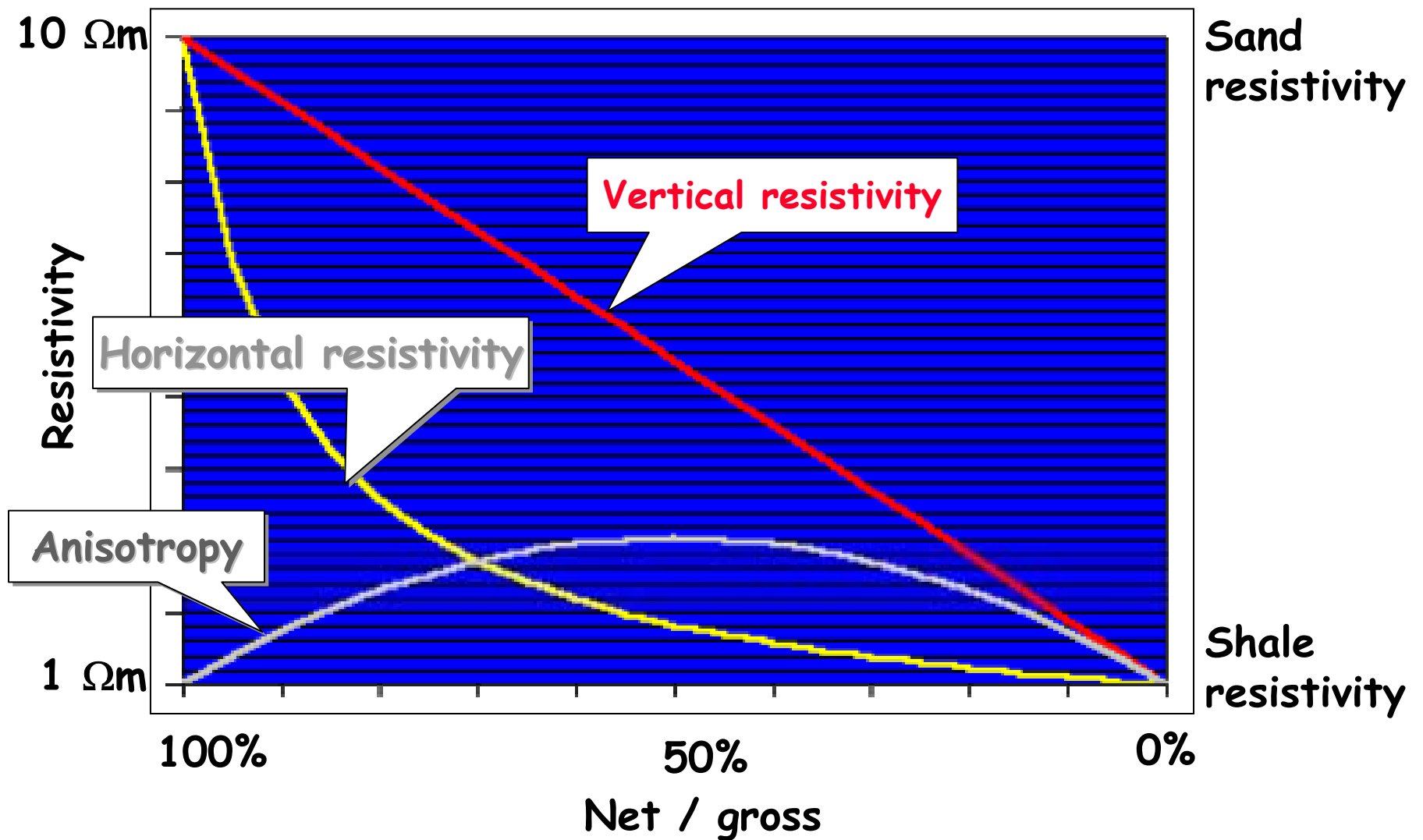

Anisotropy influence on resistivity

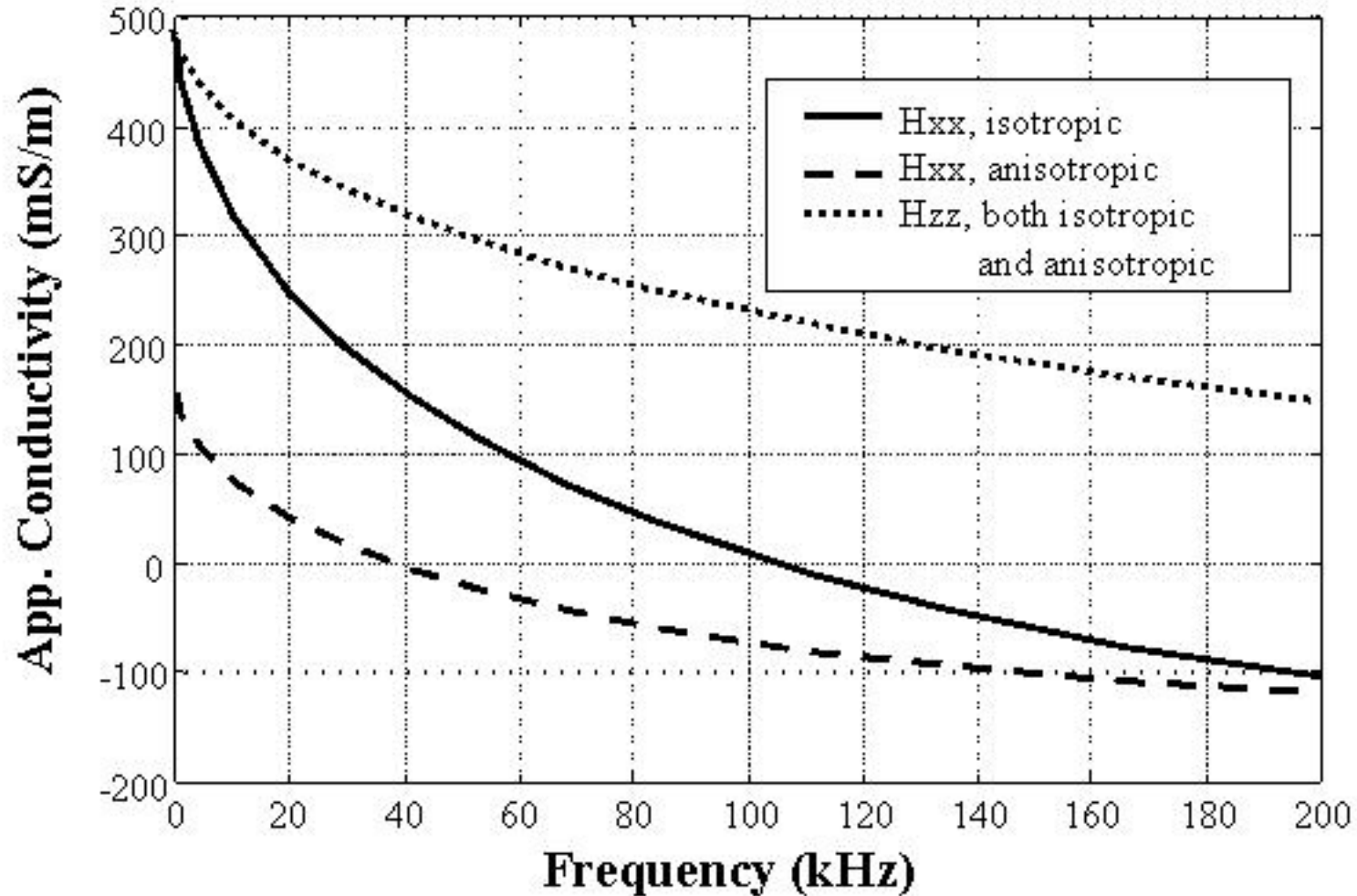

Anisotropic vs. Isotropic data match

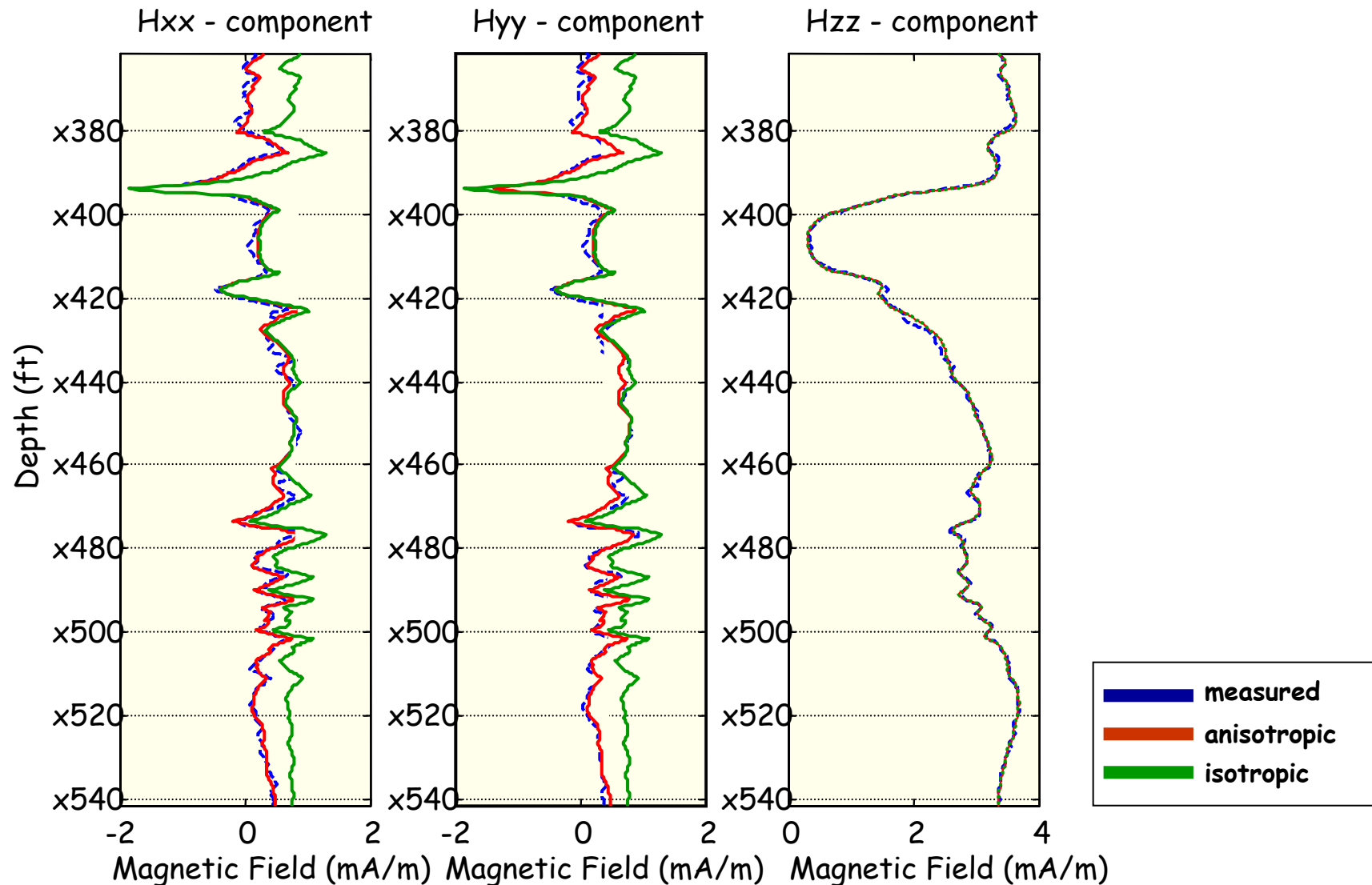

3DEX™: Inversion results

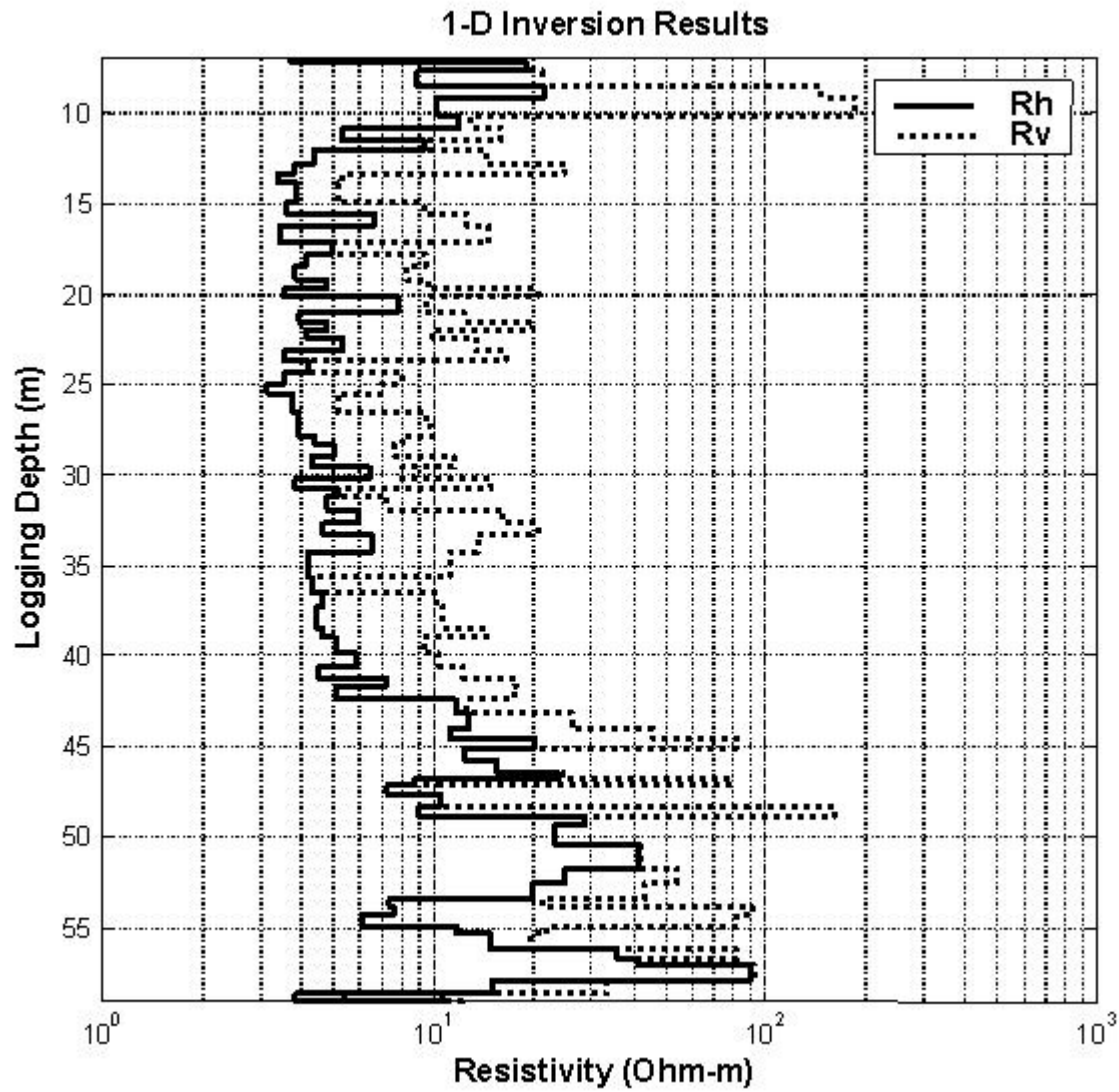

After Yu et al., 2001

3DEX™ example data

After Yu et al., 2001

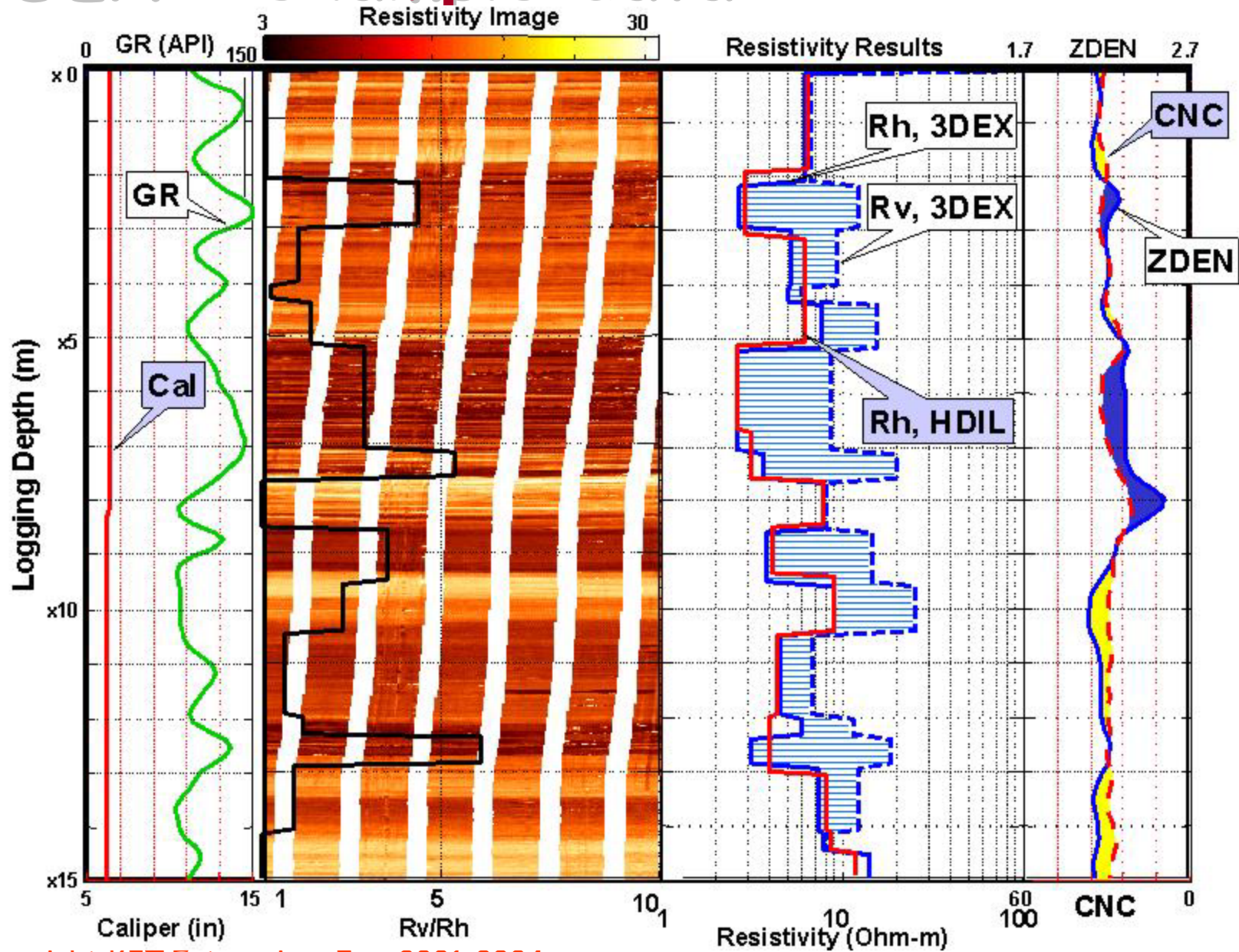

Resistivity logging: Past, Present & Future

- Introduction
- Past
 - ✕ History
 - ✕ Older tools
 - ✕ Pitfalls
- **Present**
 - ✕ Overall concept
 - ✕ Improved tools
 - ✕ Innovative tools
 - ✕ **Interpretation**
 - **Modeling & inversion**
- Future

Resistivity tools

- Laterologs
- Induction logs
- Thin bed tools
- Relationship to image tools
- Through casing resistivity
- 3D induction, example
- **Inversion of resistivity logs**

Inversion Outline

- **Inversion methodology**
- Practical implementation
- Case histories
- Conclusions

Earth Models

⇐ 1 - dimensional (D) model (vertical) ⇒

⇐ 2 - dimensional (D) (cylindrical) ⇒

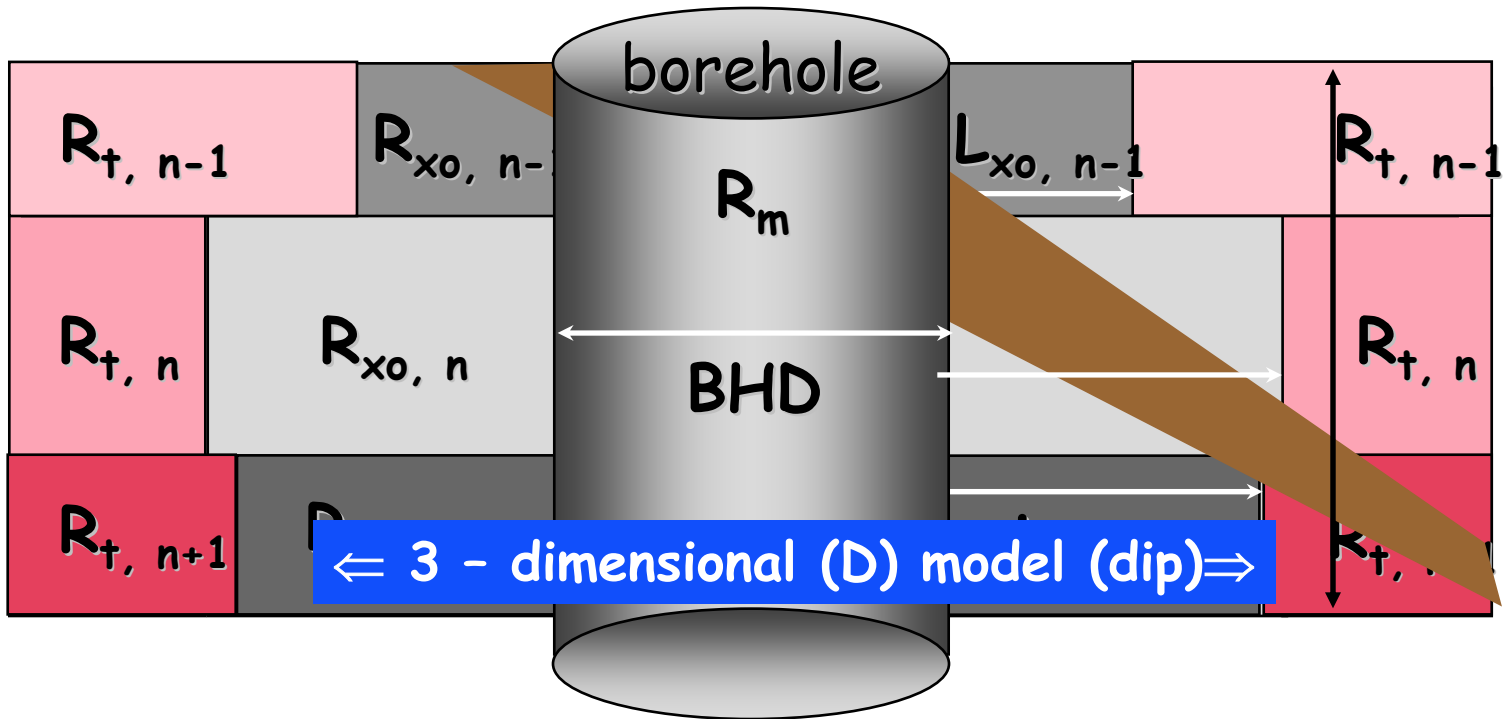

⇐ 3 - dimensional (D) model (dip) ⇒

⇐ 1 - dimensional (D) model ⇒

After Strack et al., 1998

Logging process

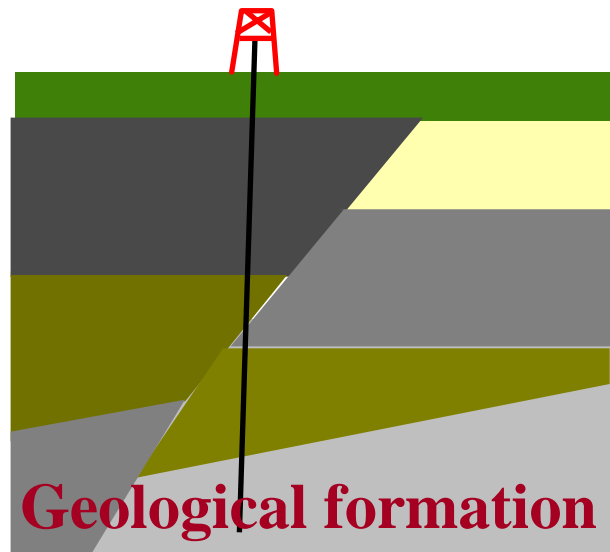

**Earth model described
by parameters
(resistivity distribution)**

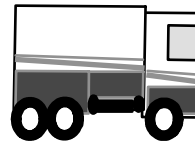

Measurements

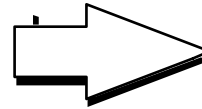

Logs

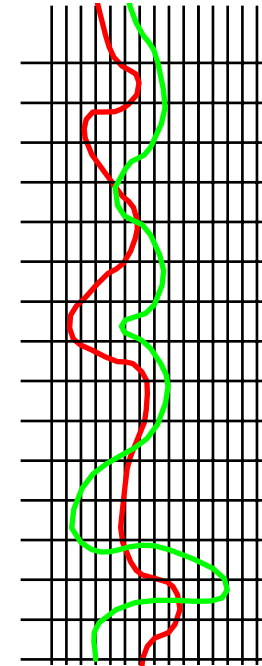

Strack, 1999

Modeling process for logs

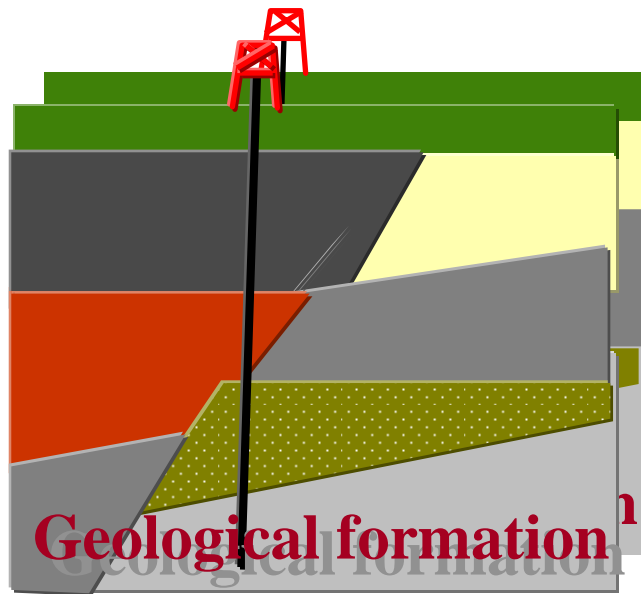

**Earth model described
by parameters
(resistivity distribution)**

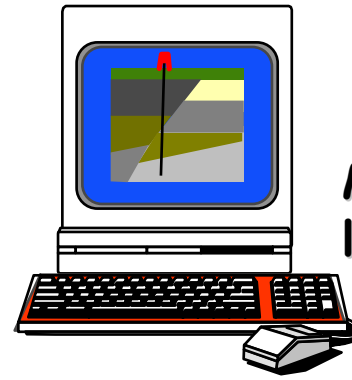

Modeling

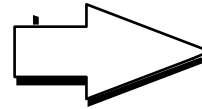

Inversion

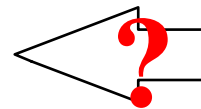

Logs
Modeled log

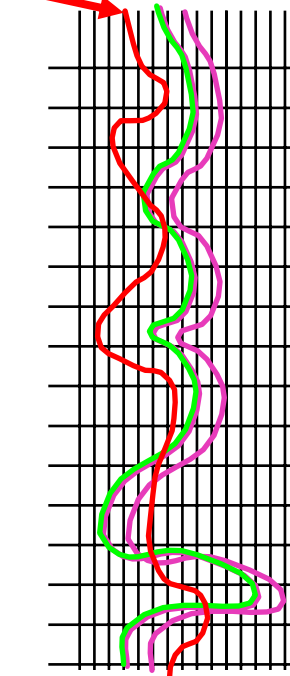

Strack, 1999

Inversion: 1D versus 2D

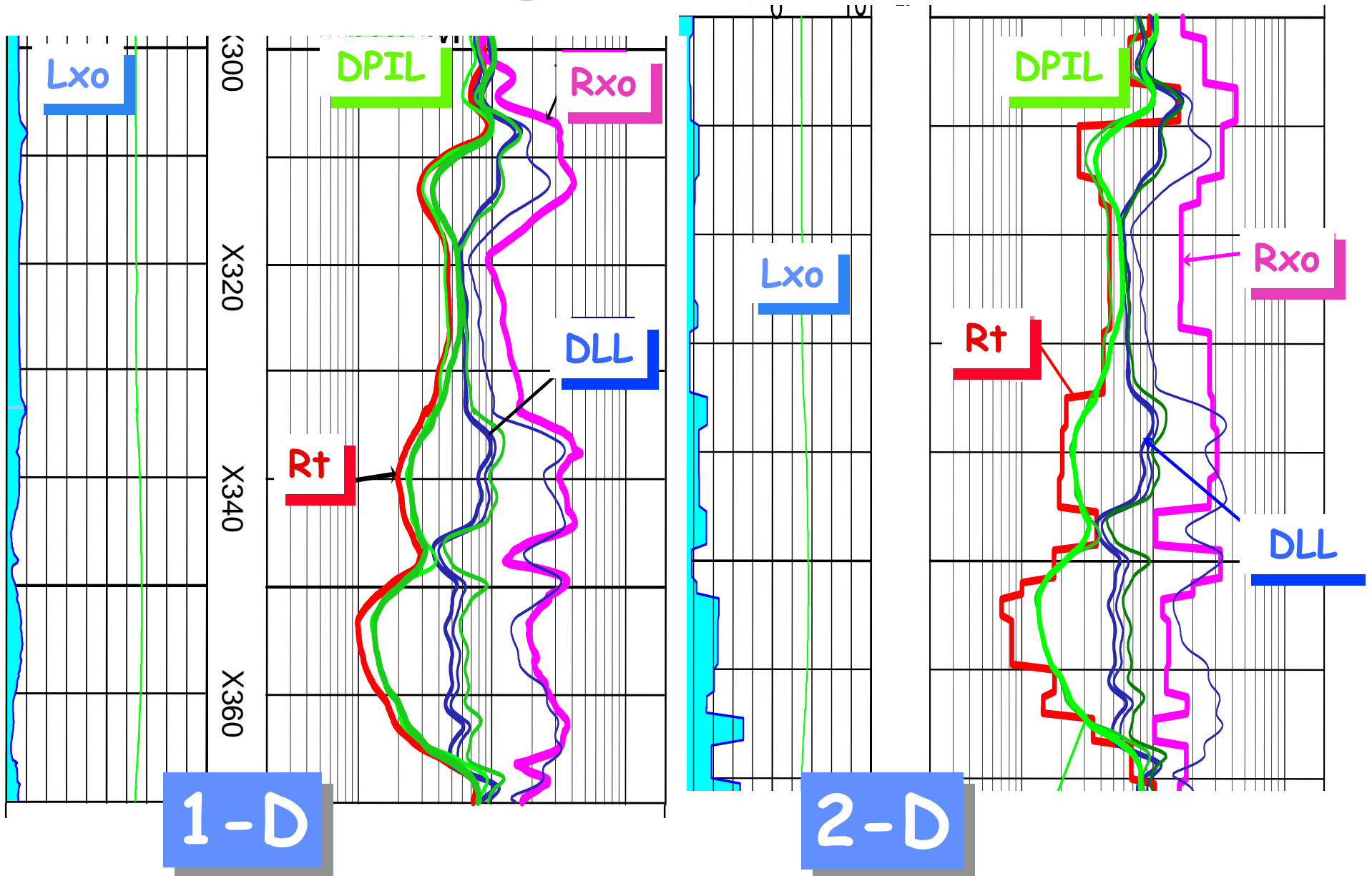

DLL underestimating oil reserves

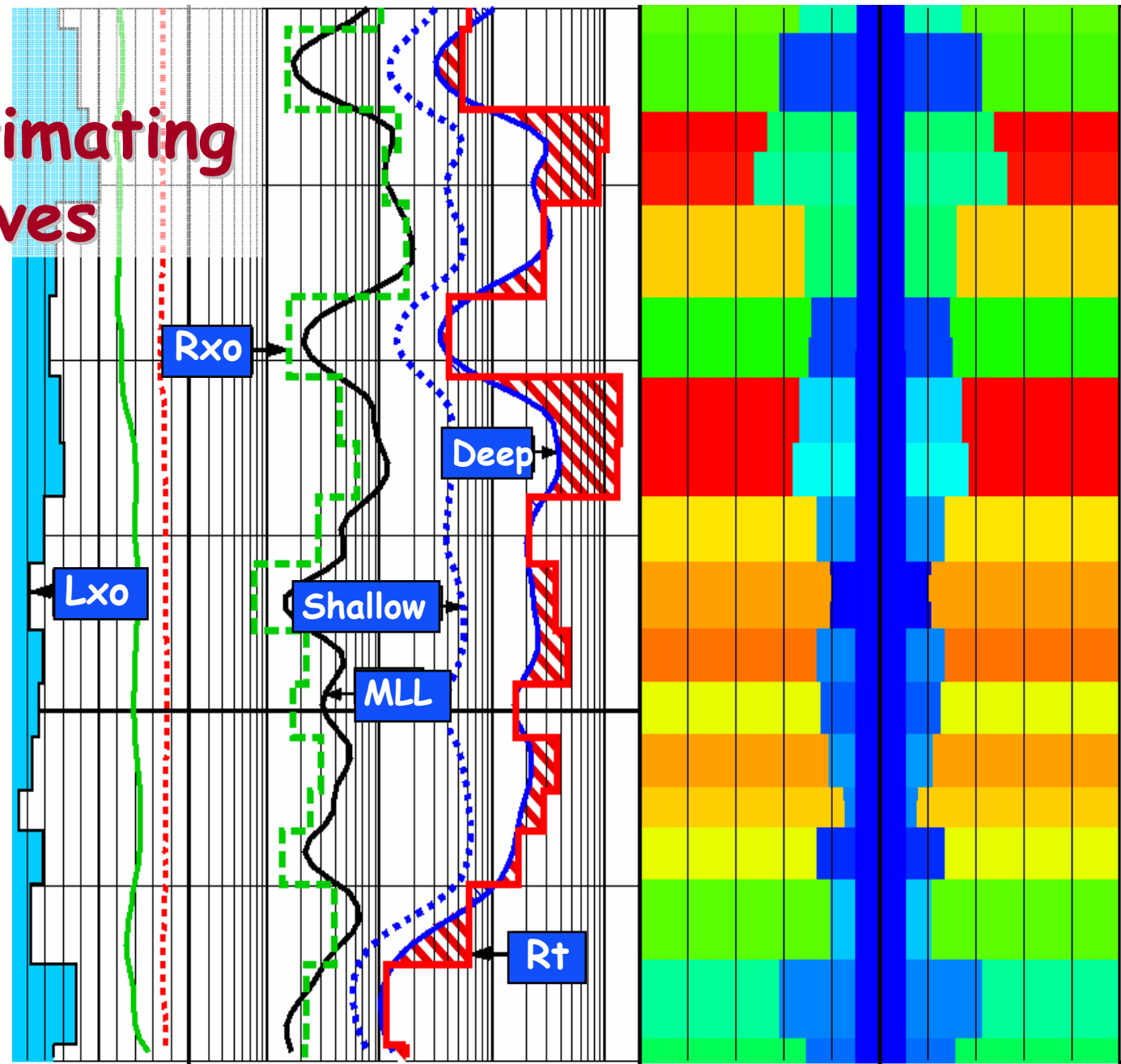

Sw Diff. Chart Fluid Vol Lithology 2-D Fluid V

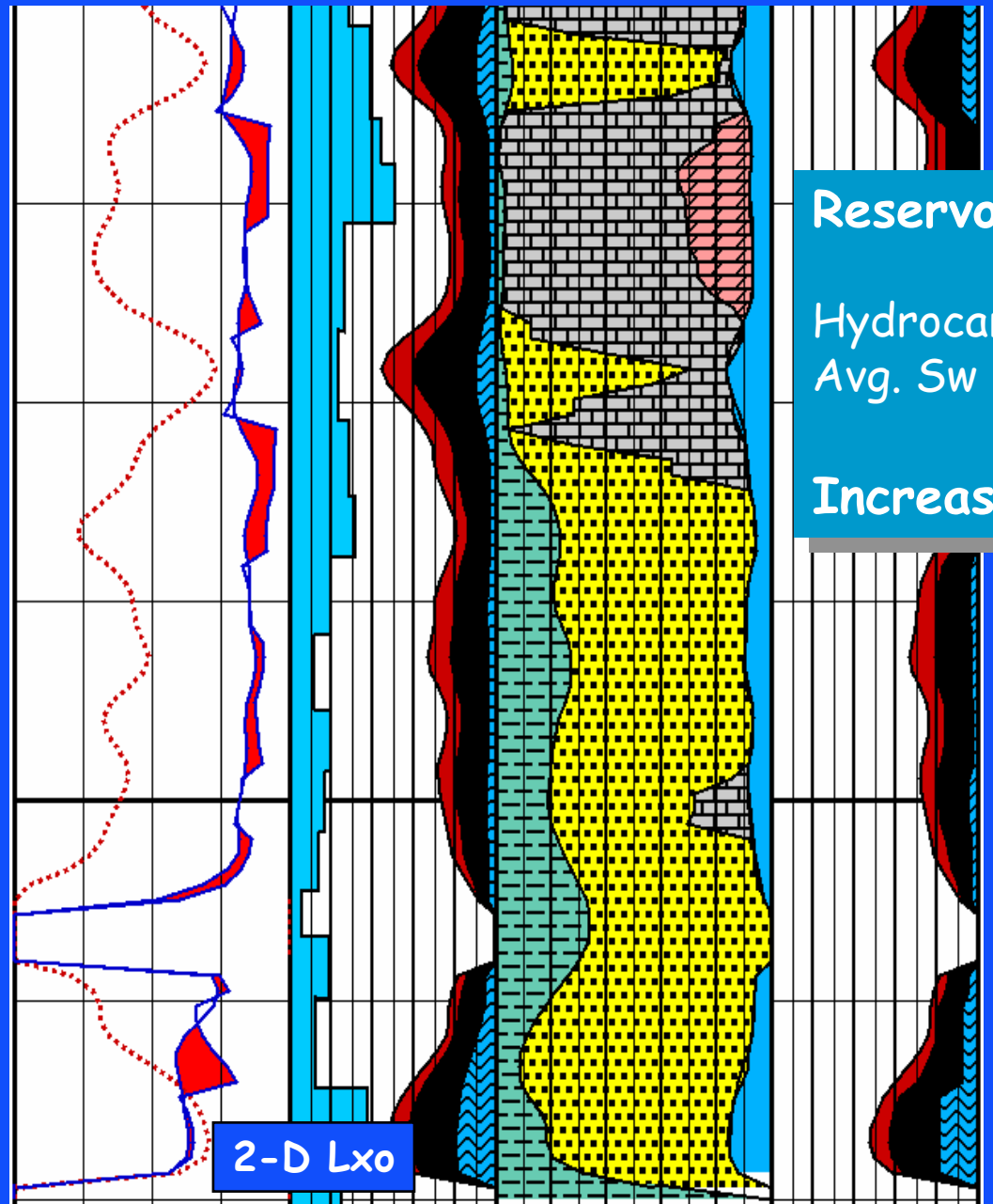

Reservoir Analysis	Chart	2-D
Hydrocarbon Meters	5.4	6.0
Avg. Sw	25%	21%
Increased OIP Estimates		10%

2-D Inversion versus chart interpretation

Inversion Conclusions:

- Better delineated oil bearing zones
- More accurate formation parameters
- Risk analysis parameters
- New ways for data integration & upscaling
- **Frontier:** horizontal well interpretation
- **Future:** Imaging

Resistivity logging: Past, Present & Future

- Introduction
- Past
 - ☒ History
 - ☒ Older tools
 - ☒ Pitfalls
- Present
 - ☒ Overall concept
 - ☒ Improved tools
 - ☒ Innovative tools
 - ☒ Interpretation
- Future

The paradigm shift

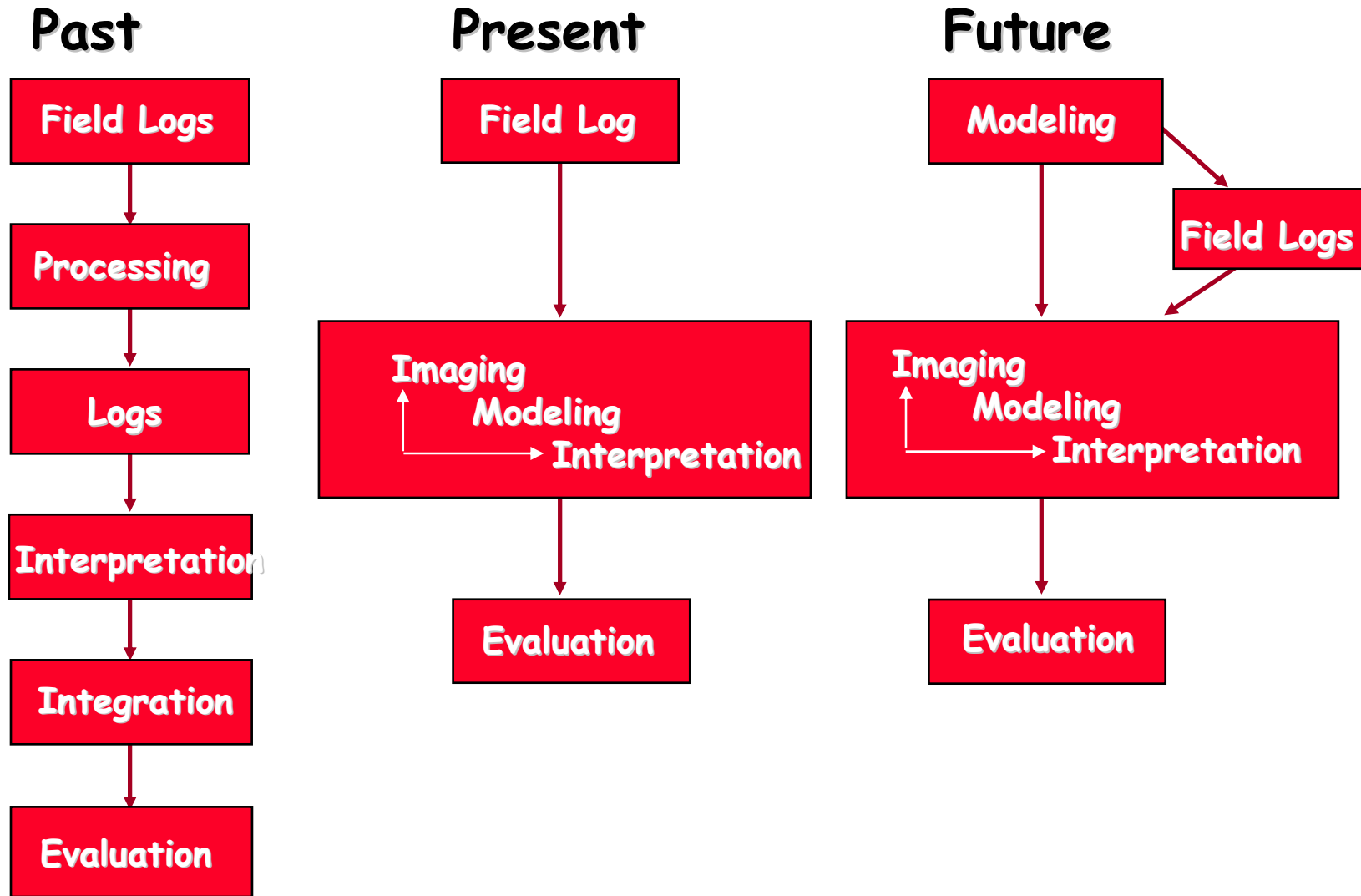

After Strack et al., 1998

Optimum use: MWD & Wireline

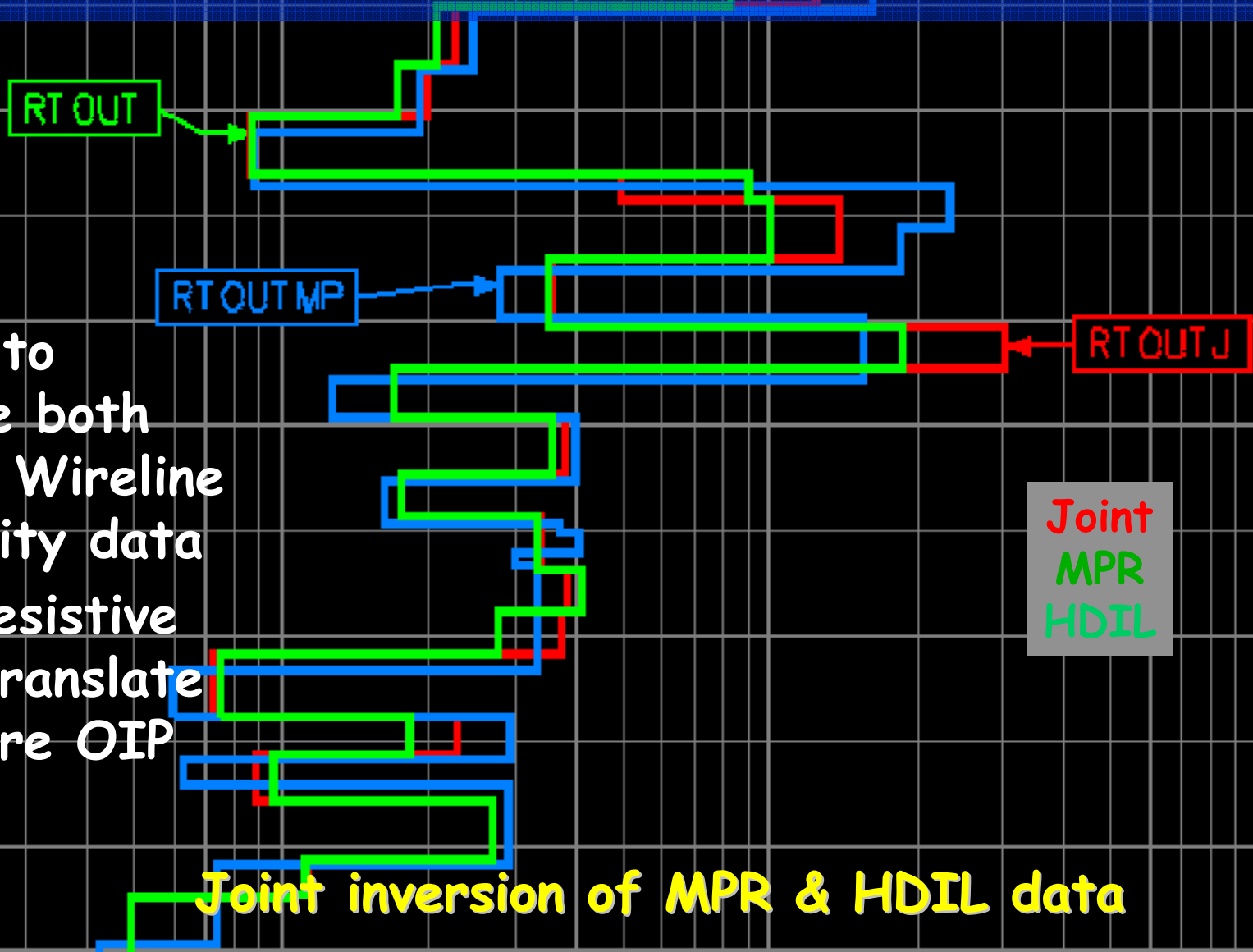

- Ability to enhance both LWD & Wireline resistivity data
- More resistive zones translate into more OIP

Joint inversion of MPR & HDIL data

Integrated Imager & Microlaterolog

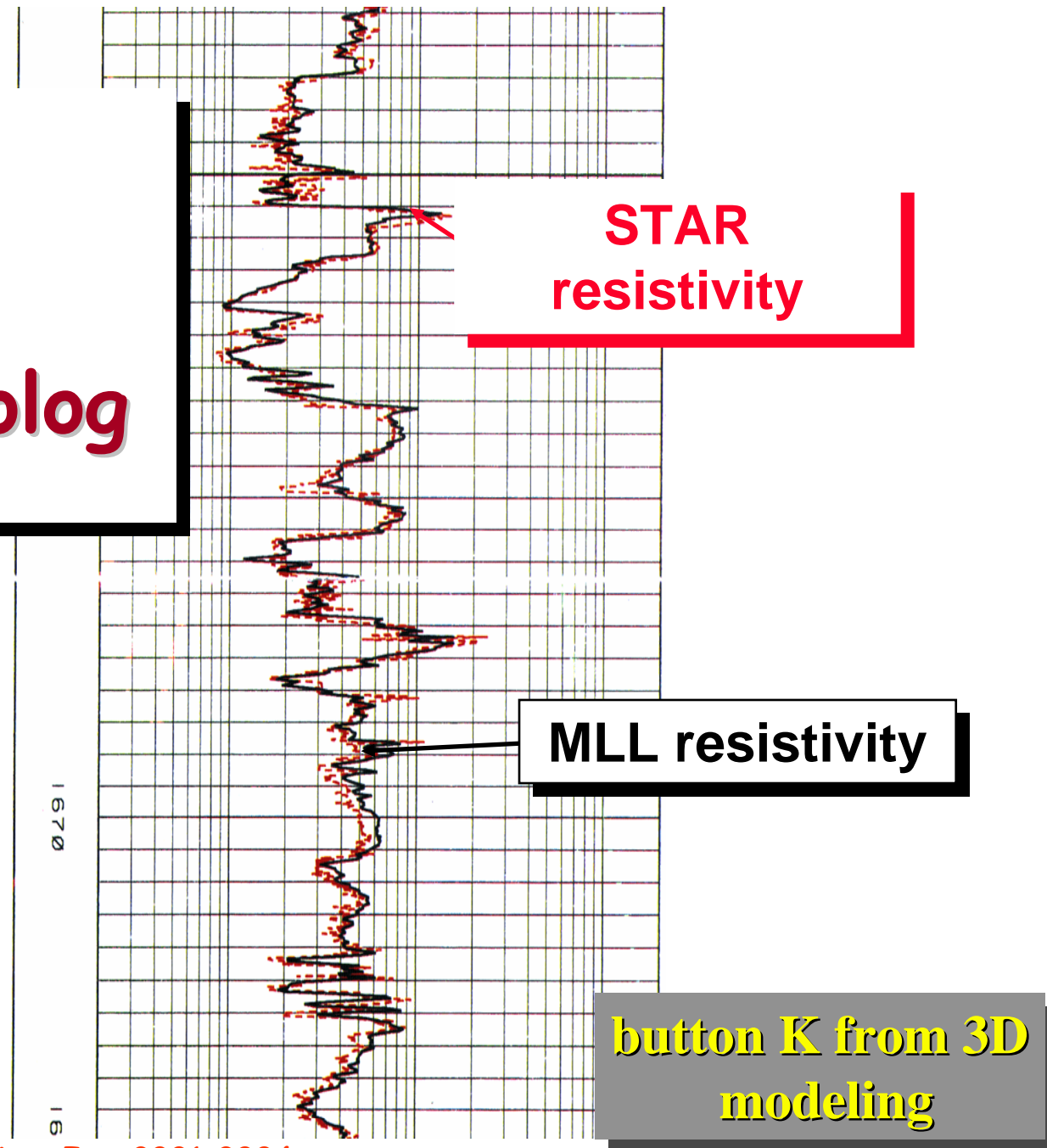

Optimum tool

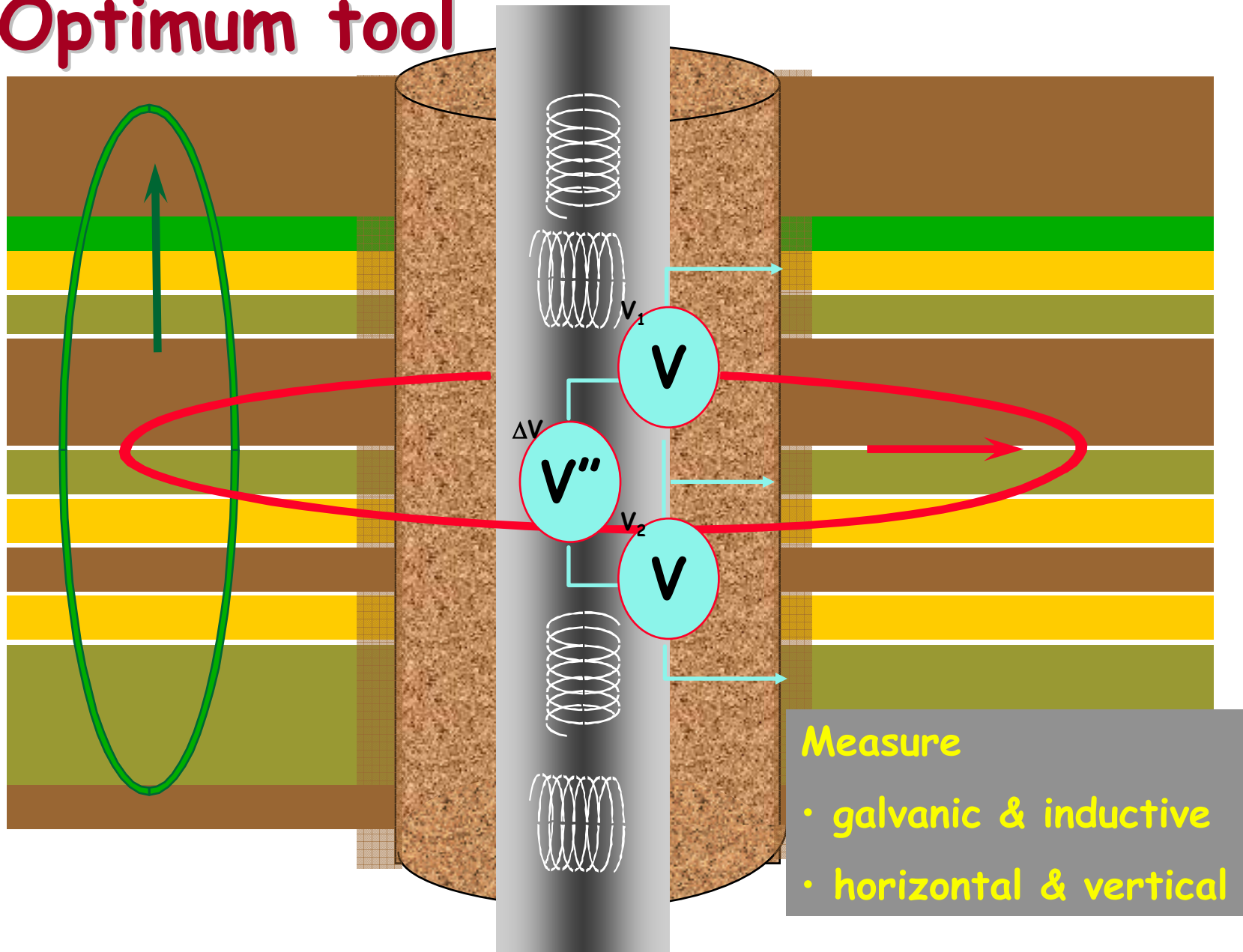

General formation evaluation trend

- Optimum use of MWD & wireline
 - ☒ MWD: routine and steering
 - ☒ wireline: imaging and deep (1-10 years then MWD)
- Advanced logs: mineralogy, downhole analysis..
- Downhole laboratories & factories
- Integrated optimized solutions

☒ tie with SWD to seismic cube

KMS Technologies – KJT Enterprises Inc.
6420 Richmond Ave., Suite 610
Houston, Texas, 77057, USA
Tel: 713.532.8144

info@kmstechnologies.com

Please visit us
<http://www.kmstechnologies.com//>